

No. P-JHC-E013
DATE 2023-12

PRODUCTS DATA SHEET

HIGH CURRENT MICRO FUSE

TYPE JHC

7358-1173 SIZE

UL. cUL approved
File No. E170721
E480488

RoHS compliant
<Complete lead-free>



MATSUO ELECTRIC Co., LTD.

Type JHC

TYPE JHC High Current Micro Fuse is designed for the purpose of external short circuit protection of the lithium ion battery of medium sizes, such as a power tool and an electric assistant bicycle.

Though it was a surface mount type, it was small and realized high current rating, because a fuse element and a terminal adopt the structure of one.

Furthermore perfectly compliant to Lead-free makes environment friendly design.

FEATURES

1. High current rating was realized because a fuse element and a terminal adopt the structure of one.
2. Surface mount type and small size of 7358 (7.3mm × 5.8mm × 4.2mm) and 1173 (11.0mm × 7.3mm × 5.9mm).
3. Surface temperature rise is 75°C or less when applying rated current. This gives little influence to the peripheral units.
4. Alumina ceramics are adopted as a case, original structure is adopted as the inside of a case, and the safety at the time of fusing is improved.
5. Suitable for automatic mounting
6. Complete lead-free

APPLICATION CLASSIFICATION BY USE

The application classification by use which divided the market and use into four is set up supposing our products being used for a broad use.

Please confirm the application classification by use of each product that you intend to use.

Moreover, please be sure to inform to our Sales Department in advance in examination of the use of those other than the indicated use.

RATING

Item	Rating
Category Temperature Range	-40 ~+125°C
Rated Current	30A, 40A, 50A, 60A, 80A, 100A
Rated Voltage	35VDC, 60VDC, 84VDC, 110VDC
Voltage Drop	Refer to CATALOG NUMBERS AND RATING
Insulation Resistance (between terminals and case)	1000MΩ or more
Fusing Characteristics	Fusing within 1 minute if the current is 250% of rated current.
Clearing Characteristics	Breaking voltage : Rated Voltage
	Breaking Current : Refer to CATALOG NUMBERS AND RATING

ORDERING INFORMATION

JHC			3502		503		R		44E	
Type	Code	Voltage	Code	Rated current	Code	Rated current	Code	Package type	Code	Case size
JHC	3502	35V	303	30 A	603	60 A	R	φ 180 Reel	44E	7.3 × 5.8
	6002	60V	403	40 A	803	80 A	N	φ 330 Reel	59F	11.0 × 7.3
	8402	84V	503	50 A	104	100 A				
	1103	110V								

CATALOG NUMBERS AND RATING

Dec., 2023

Catalog number	Case size	Rated current A	Internal resistance mΩ (Max.)	Voltage drop mV (Max.)	Rated voltage VDC	Breaking current A	
JHC 3502 303 □ 44E	7.3×5.8	30	1.9	80	35	300*	
JHC 6002 303 □ 44E					60		
JHC 3502 403 □ 44E		40	1.5		35		
JHC 6002 403 □ 44E					60		
JHC 3502 503 □ 44E		50	1.2		35		
JHC 6002 503 □ 44E					60		
JHC 3502 603 □ 44E		60	1.1	90	60		
JHC 6002 603 □ 44E				35			
JHC 3502 803 □ 44E		80	0.8	100	35	600	
JHC 3502 104 □ 44E		100	0.7		35		
JHC 1103 303 □ 59F	11.0×7.3	30	2.0	80	110	1000	
JHC 1103 403 □ 59F		40	1.5			90	1500
JHC 1103 503 □ 59F		50	1.3				84
JHC 1103 603 □ 59F		60	1.1				
JHC 8402 803 □ 59F		80	0.8				
JHC 8402 104 □ 59F		100	0.7	100			

• For the taping type, the packing code "R or N" will be entered in □. For 59F, only "N" will be entered in □.

• Catalog numbers are approved by UL. cUL.(File No.E170721,E480488)

* JHC 7.3 x 5.8 size 40A and 50A also have a lineup of products with a breaking current of 1000A, so please contact our sales department.

DIMENSIONS

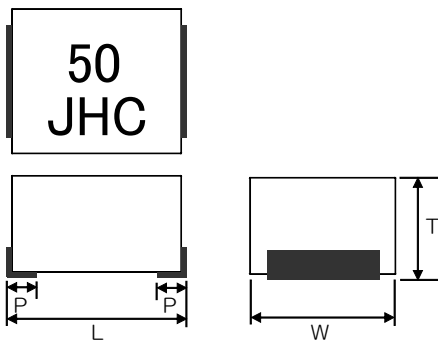

Main body : Ceramic case

Terminal : Tin plating

(mm)

Case size	Case code	L	W	T	P
7358	44E	7.3±0.3	5.8±0.2	4.2±0.2	1.2±0.3
1173	59F	11.0±0.3	7.3±0.3	5.9±0.2	1.8±0.3

MARKING

Code : Rated current	Code : Rated current
30 : 30A	60 : 60A
40 : 40A	80 : 80A
50 : 50A	100 : 100A

CONSTRUCTION

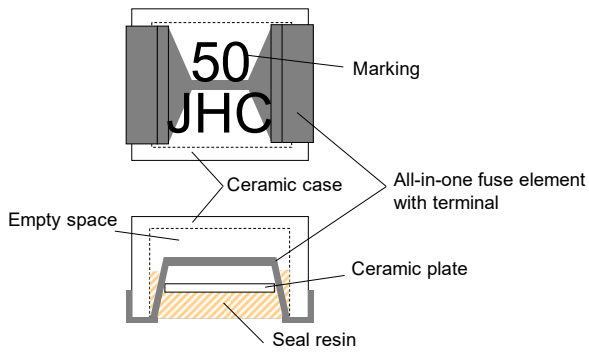

Name	Material, standard, and treatment
All-in-one fuse element with terminal	Copper Alloy (Tin plating terminal)
Ceramic case	Alumina ceramics
Ceramic plate	Alumina ceramics
Seal resin	Silicone resin
Marking	UV curable resin
Empty space	—

RECOMMENDED PAD DIMENSION

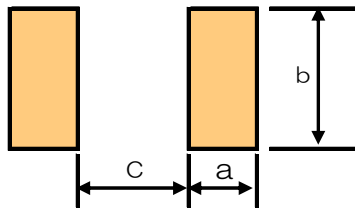

(mm)		
	Size 7358	Size 1173
a	2.7	3.3
b	5.8	7.3
c	4.4	6.9

(Reflow)

STANDARD TEST BOARD

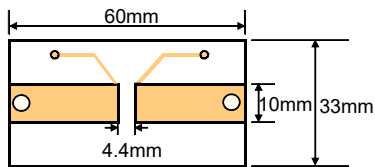

Glass epoxy body on one side
Board thickness : 1.6mm
Thickness of Copper layer : 400 μ m
Rated Current : 30~50A

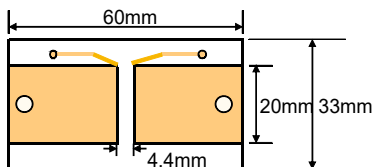

Glass epoxy body on one side
Board thickness : 1.6mm
Thickness of Copper layer : 500 μ m
Rated Current : 60~100A

PERFORMANCE

No	Item	Performance	Test method
1	Temperature rise	Temperature rise shall not exceed 75°C	Apply rated current
2	Current-carrying capacity	Shall not open w ithin 1 hour.	Apply 100% of rated current
3	Clearing characteristics	Arc shall not be continued. No ignition. Marking shall be legible No bursting of the fuse	Breaking voltage : Rated voltage Breaking current : Refer to CATALOG NUMBERS AND RATING
4	Voltage drop	Voltage drop is below the value specified in CATALOG NUMBERS AND RATING.	Apply rated current
5	Fusing characteristics	Fusing w ithin 1 min.	Apply 250% of rated current (Ambient temperature: 10~30°C)
6	Insulation resistance	1000MΩ or more	Insulation resistance between terminals and case(ceramics)
7	Electrode strength (Bending)	No mechanical damage. Resistance change after the test shall be w ithin ± 20%.	Board supporting width : 90mm Bending speed : Approx. 0.5mm/s Duration : 5 s Bending : 3mm
8	Shear test	No mechanical damage. Resistance change after the test shall be w ithin ± 20%.	Applied force : 20N Duration : 10s Tool : R0.5 Direction of the press : side face
9	Core body strength	No mechanical damage. Resistance change after the test shall be w ithin ± 20%.	Supporting dimension : 3.65mm Applied force : 20N Duration : 10s Tool : R0.5 Direction of the press : thickness direction of product
10	Solderability (Solder Wetting time)	Solder Wetting time : w ithin 3s	Solder : Sn-3Ag-0.5Cu Temperature : 245±5°C meniscograph method
11	Solderability (new uniform coating of solder)	The dipping surface of the terminals shall be covered more than 95% w ith new solder.	Solder : Sn-3Ag-0.5Cu Temperature : 245±5°C Dipping : 3s
12	Resistance to soldering heat	Marking shall be legible. No mechanical damage. Resistance change after the test shall be w ithin ± 20%.	Dipping (1 cycle) Preconditioning : 100~150°C / 60s Temperature : 265±3°C / 6~7s Reflow (2 cycle) Preconditioning : Lower than 180°C 1~2min Peak : 250±5°C 5s Holding : 230~250°C 30~40s Cooling : More than 2min Manual soldering (2 cycle) Temperature : 350±10°C Duration : 3~4s Measure after 1hour left under room temperature and humidity.
13	Solvent resistance	Marking shall be legible. No mechanical damage. No significant irregularity in the appearance.	Dipping rinse Solvent : Isopropyl alcohol Duration : 90s
14	Vibration	No mechanical damage. Resistance change after the test shall be w ithin ± 20%.	Frequency rage : 10~55~10Hz/min Vibration amplitude : 1.5mm Duration : 2 hours in each of XYZ directions (total : 6 hours)
15	Shock	No mechanical damage. Resistance change after the test shall be w ithin ± 20%.	Peak value : 490m/s ² Duration : 11ms 6 aspects × 3 times (total: 18 times)
16	Thermal shock	No mechanical damage. Resistance change after the test shall be w ithin ± 20%.	-55±3°C : 30min Room temperature : 2~3min or less 125±2°C : 30min Room temperature : 2~3min or less Repeat above step for 10 cycles
17	Moisture resistance	No mechanical damage. Resistance change after the test shall be w ithin ± 20%.	Temperature : 85±3°C Humidity : 85±5%RH Duration : 1000h
18	Load life	No mechanical damage. Resistance change after the test shall be w ithin ± 20%.	Temperature : 85±2°C Applied current : Rated current×70% Duration : 1000h
19	Moisture resistance load	No mechanical damage. Resistance change after the test shall be w ithin ± 20%.	Temperature : 85±3°C Humidity : 85±5%RH Applied current : Rated current×70% Duration : 1000h
20	Stability	No mechanical damage. Resistance change after the test shall be w ithin ± 20%.	Temperature : 125±2°C Duration : 1000h

FUSING CHARACTERISTICS

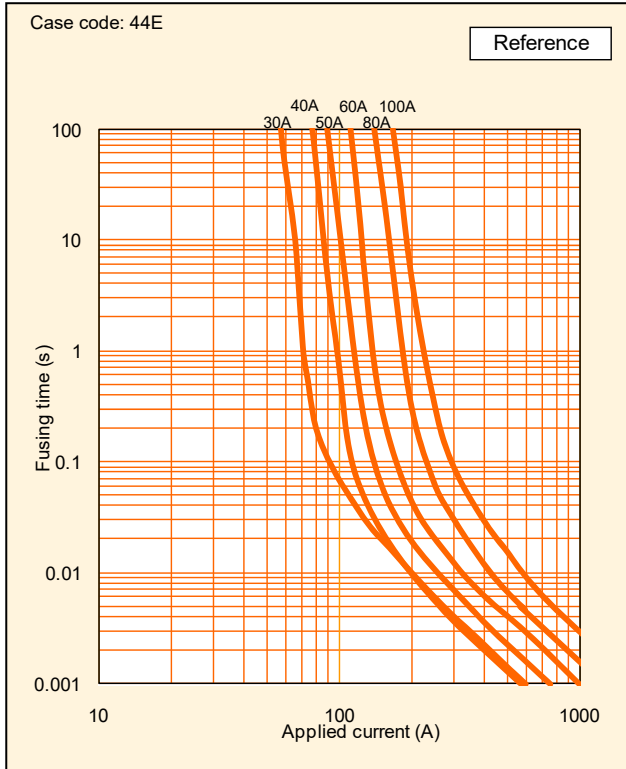

I²T - T CHARACTERISTICS

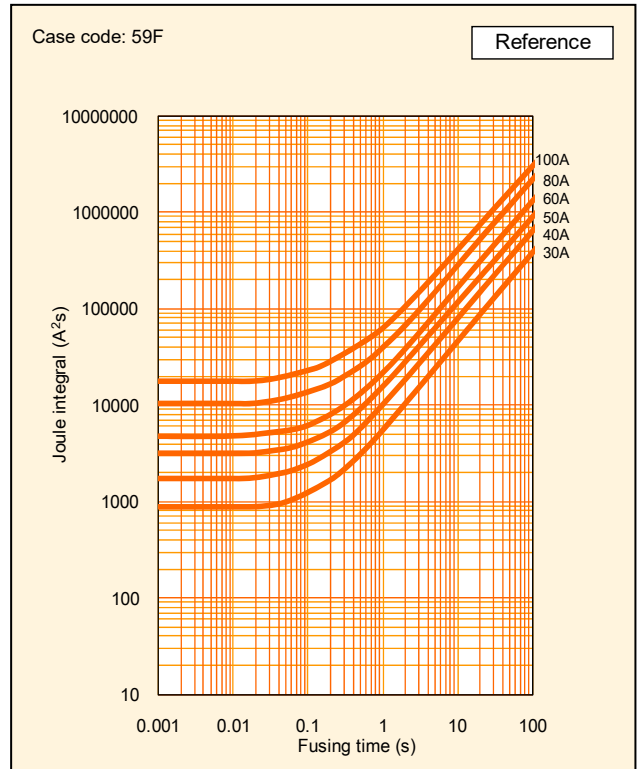
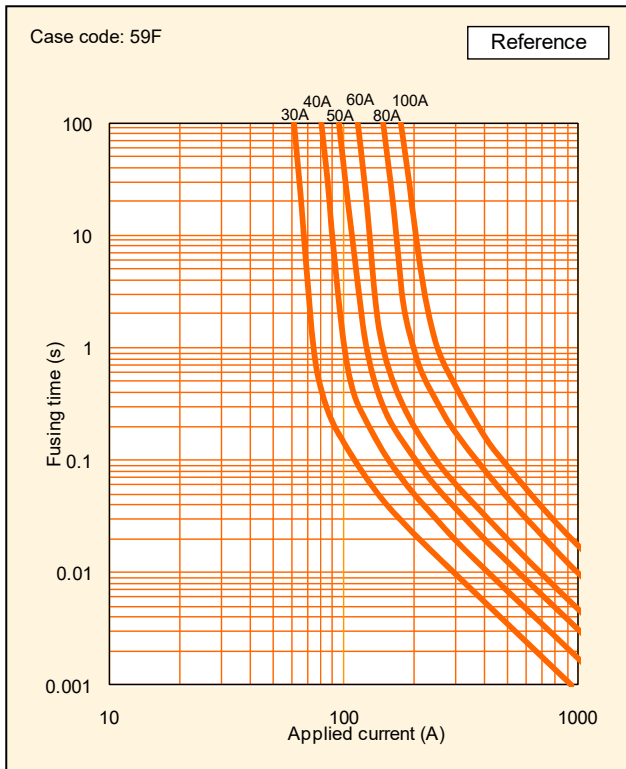
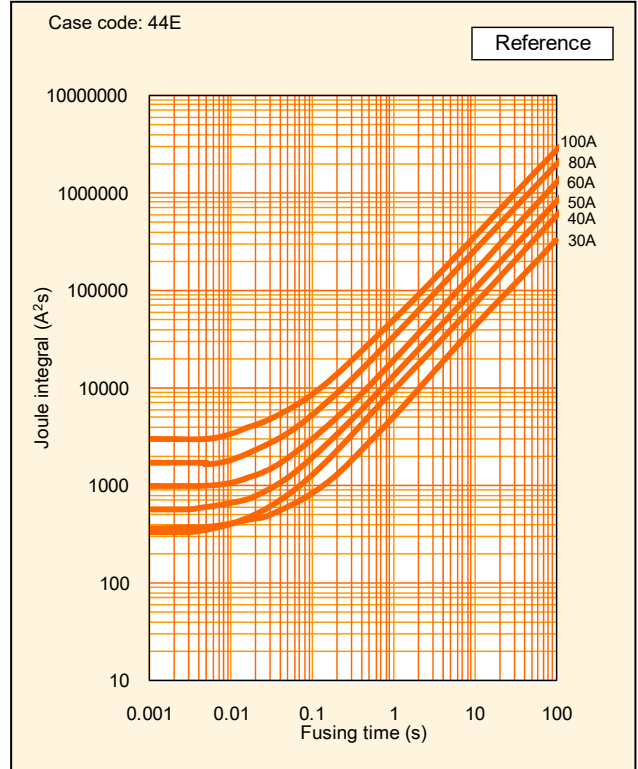

DISTRIBUTION OF FUSING CHARACTERISTICS

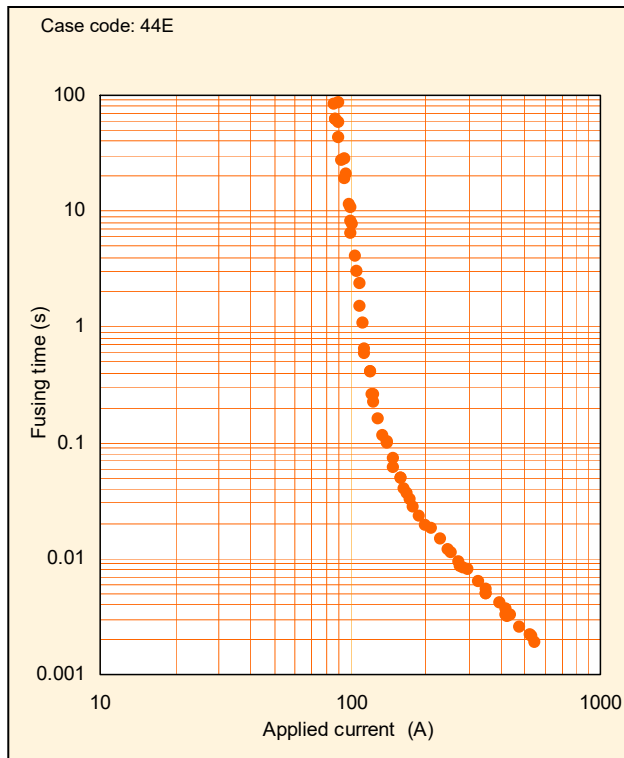

DISTRIBUTION OF FUSING TIME

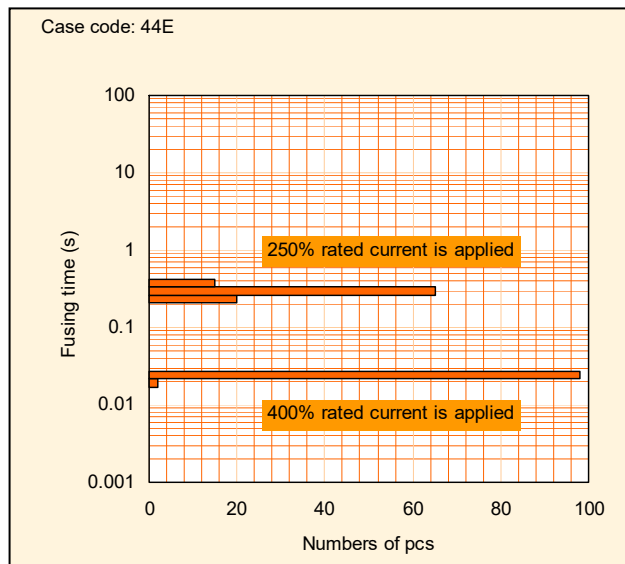

DETERMINATION OF RATED VALUE AND SELECTION OF MICRO FUSE (TYPE JHC)

Determine the rated value of the micro fuse, and select the micro fuse for your circuit. If you select the micro fuse, safety of your circuit can be ensured.

How to determine the rated value of the micro fuse is described below:

■ Flow for fuse selection

1. Measurement of circuit values using actual device

Measure the circuit values, such as operating current of the circuit.

2. Calculation from operating current

From the obtained operating current and the category temperature, calculate minimum rated value to determine the applicable fuse.

3. Calculation from overload current

From the obtained overload current, calculate the maximum rated value to determine the applicable fuse.

4. Calculation from inrush current

From the inrush current, calculate the minimum rated value to determine the applicable fuse.

5. Final determination of rated value

From the calculation results of steps 2 through 4, determine the rated value.

6. Operation check using actual device

After selecting the rating, confirm if the device works properly under the pre-determined conditions.

■ Fuse selection

1. Measurement of circuit values using actual device

Before determining the rated value of the fuse, preliminarily measure the following condition by using the actual device.

1-1. Operating current

Using an oscilloscope or equivalents, measure operating current of the circuit.

1-2. Overload current

Using an oscilloscope or equivalents, measure the overload current that needs to break the circuit.

1-3. Inrush current

Using an oscilloscope or equivalents, measure the inrush current of circuit at power-on or power-off. In addition, determine the number of inrush current applied.

1-4. Category temperature

Measure the ambient temperature of the fuse circuit.

<The notes to the design of substrate wiring>

In a 25°C environment under normal circumstances, please design substrate wiring so that the surface temperature of a fuse does not exceed 80°C.

EXAMPLE TO SELECT RATINGS OF TYPE JHC

<Fuse selection>

Effective operating current : 30 A

Effective overload current : 140 A

Inrush current waveform : Fig. A

(Pulse width : 2 ms, Wave height : 300 A)

Numbers to withstand inrush current : 100,000 times

Category temperature : 85°C

Operating time : 4,000h

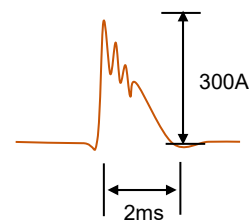

Fig. A : Inrush current waveform

2. Calculation from operating current

2-1. Measurement of operating current

Using an oscilloscope or equivalents, measure operating current (effective current) of the actual circuit.

Example : Effective operating current = 30 A

2-2 Derating

① Temperature derating factor

Using Fig. B, find the temperature derating factor correspond to the Temperature.

However, in order to be allowed to check an operating condition in use to the apparatus used for a long time that the operating time exceeds 4,000 h, please ask our Sales Department.

② Rated derating factor

Rated derating factor = 0.94 (Constant irrespective of temperature)

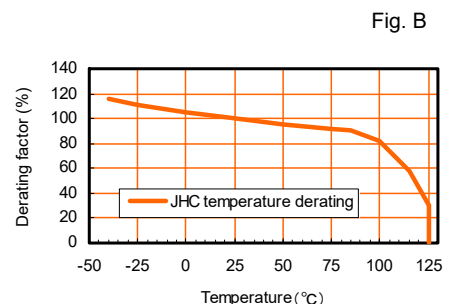

Fig. B

Use Formula 1 to calculate the rated current of the fuse to be used for the circuit.

Rated current of fuse \geq Operating current / (① × ②) ... Formula 1

Example : Category temperature = 85°C, Operating current =30 A

- ①Temperature derating factor = 0.90 (Refer to Fig. B.)
- ②Rated derating factor = 0.94 (Constant irrespective of temperature)

Calculation using Formula 1 :

$$\text{Rated current} \geq 30 / (0.90 \times 0.94) = 35.5\text{A}$$

The above calculation result shows that the fuse with rated current of 35.5A or more should be selected for this circuit.

Type JHC, with rated current of 50 A and 40A can be selected.

3. Calculation from overload current

3-1 Measurement of overload current

Using oscilloscope or equivalents, measure overload current that needs to break circuit.

Example : Effective overload current = 140 A

3-2 Calculation from overload current

Determine rated current so that overload current can be 2.5 times larger than rated current.

Use Formula 2 to calculate rated current of fuse.

Rated current of fuse \leq Overload current/2.5 ... Formula 2

Example : Overload current = 140 A

Use Formula 2 to calculate the rated current.

$$\text{Rated current} \leq 140 / 2.5 = 56 \text{ A}$$

The above calculation result shows that the fuse with rated current of 56 A or less should be selected for this circuit.

Type JHC, with rated current of 50 A and 40A can be selected.

4. Calculation from inrush current

4-1 Measurement of inrush current waveform

Using an oscilloscope or equivalent, measure waveform of inrush current of actual circuit.

4-2 Creation of approximate waveform

Generally, waveform of inrush current is complicated. For this reason, create the approximate waveform of inrush current as shown on Fig. C to simplify calculation.

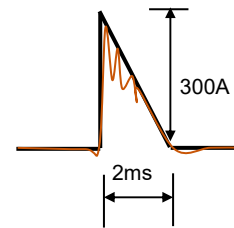

Fig. C : Inrush current waveform
Red line : Actual measurement waveform
Black line : Approximate waveform

4-3 Calculation of I²t of inrush current

Calculate I²t (Joule integral) of approximate waveform.

The formula for this calculation depends on the approximate waveform.

Refer to Table A.

Example : Pulse applied = 2 ms, Peak value = 300 A

Approximate waveform = Triangular wave

Since the approximate waveform is a triangular wave, use the following formula for calculation.

$$I^2t \text{ of rush current} = 1/3 \times I_m^2 \times t \dots \text{Formula 3} \quad (I_m : \text{Peak value, } t : \text{Pulse applying time})$$

Use Formula 3 to calculate I²t of the inrush current:

$$I^2t = 1/3 \times 300 \times 300 \times 0.002 = 60 \text{ (A}^2\text{s)}$$

JOULE-INTEGRAL VALUES FOR EACH WAVEFORM

Table A

Name	Waveform	I ² t	Name	Waveform	I ² t
Sine wave (1 cycle)		$\frac{1}{2} I_m^2 t$	Trapezoidal wave		$\frac{1}{3} I_m^2 t_1 + I_m^2 (t_2 - t_1) + \frac{1}{3} I_m^2 (t_3 - t_2)$
Sine wave (half cycle)		$\frac{1}{2} I_m^2 t$	Various wave 1		$I_1 I_2 t + \frac{1}{3} (I_1 - I_2)^2 t$
Triangular wave		$\frac{1}{3} I_m^2 t$	Various wave 2		$\frac{1}{3} I_1^2 t_1 + \{I_1 I_2 + \frac{1}{3} (I_1 - I_2)^2\} (t_2 - t_1) + \frac{1}{3} I_2^2 (t_3 - t_2)$
Rectangular wave		$I_m^2 t$	Charge/discharge waveform		$\frac{1}{2} I_m^2 \tau$

* Following formula is generally used for calculation of I²t as i(t) equal to current.

$$I^2 t = \int_0^t i^2 (t) dt$$

4-4 Search of load ratio

- ① Set up number of cycles to withstand.
(generally 100,000 times)
- ② Obtain load ratio from Pulse resistance characteristics.
(Fig. D)

Example : 100,000 times is required against inrush current applied.

The load ratio is 35% or less from Fig. D.

PULSE RESISTANCE CHARACTERISTICS

Fig. D

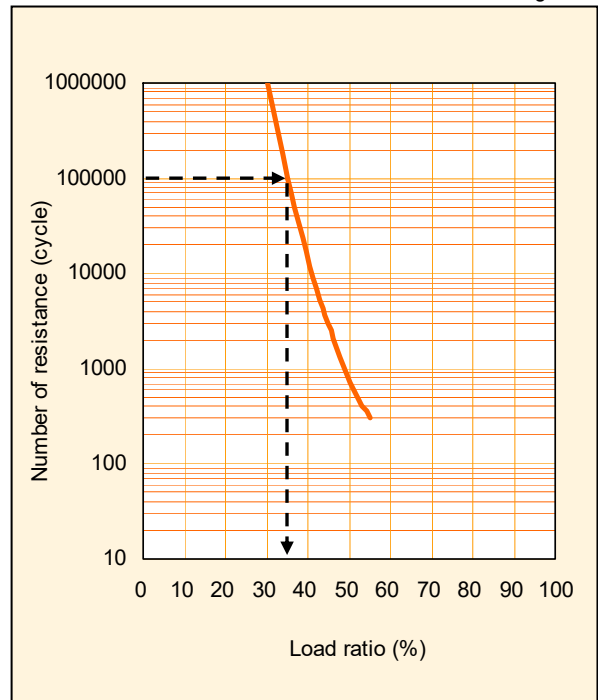

4-5 Calculation from Joule integral and load ratio

Use Formula 4 to calculate the standard I^2t for the fuse to be used.

Standard I^2t of fuse > (I^2t of inrush current/load ratio)
.....Formula 4

Example : I^2t of pulse = 60 A²s,
Pulse applied = 2 ms, Required load ratio = 35%

From Formula 4,
Standard I^2t of fuse > $60/0.35 = 171.4$ (A²s)
The standard I^2t of the fuse should be 171.4 (A²s) or more.
Since the rush pulse applied is 2 ms, obtain the intersection of 2 ms (horizontal axis) and 171.4 A²s (vertical axis) from Fig. E (refer to the arrow shown in Fig. E).
Select a fuse whose curve is above the intersection. Type JHC with rated current of 50 A and 40A should be selected.

JOULE INTEGRAL VS. FUSING TIME

Fig. E

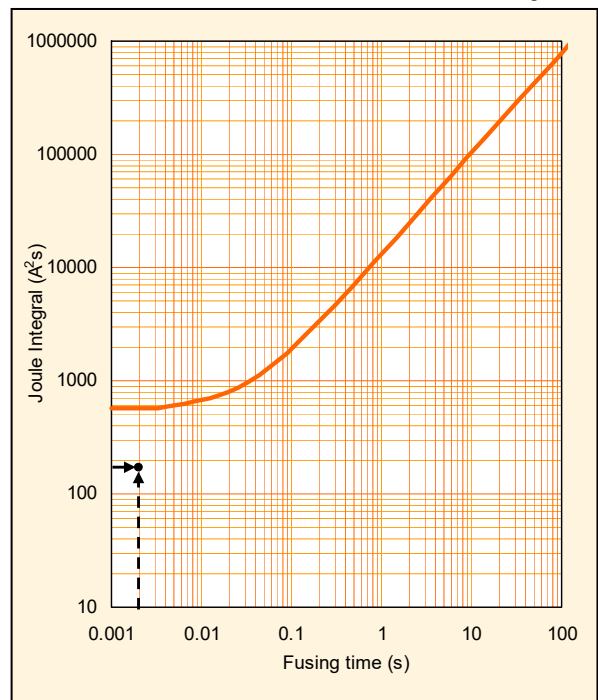

5. Final determination of rated value

Determine the rated current of micro fuse. Rated current should meet all the calculation results.

Example : Rated current of 50 A and 40A meets the all requirement.

6. Operation check using actual device

After selecting rating, confirm if the device works properly under pre-determined conditions.



Application Notes for Micro Fuse

1. Circuit Design

Before using HIGH CURRENT MICRO FUSE, be sure to fully check after confirming operating conditions and Micro Fuse characteristics.

When determining the rated current, be sure to observe the following items :

- (1) HIGH CURRENT MICRO FUSE should always be operated below the value considered in the rated derating rate and temperature derating rate for rated current.
- (2) HIGH CURRENT MICRO FUSE should always be operated below rate for rated current.
- (3) HIGH CURRENT MICRO FUSE should be selected with rated value to be certainly fused at overload current.
- (4) When HIGH CURRENT MICRO FUSE are used in inrush current applications, please confirm sufficiently inrush resistance of HIGH CURRENT MICRO FUSE.
- (5) Please do not apply the current exceeding the rated breaking current to HIGH CURRENT MICRO FUSE.
In addition, I would like confirmation beforehand not to have possibilities to cut it off normally when you use it by a high inductance circuit.
- (6) Use HIGH CURRENT MICRO FUSE under the condition of category temperature.
- (7) HIGH CURRENT MICRO FUSE should not be used in the AC power source and primary power source.
- (8) In a 25°C environment under normal circumstances, please design substrate wiring so that the surface temperature of a fuse does not exceed 80°C.
And, please use after checking that turn on operating current and overload current by an actual substrate in advance, and it is satisfactory.

Please confirm whether the selection of the rating of HIGH CURRENT MICRO FUSE was appropriate in the actual device (state of final product).
In that case, after considering the variation due to the product, repeat the tests for normal use and predictable abnormalities to confirm the validity of the selection.

2. Assembly and Mounting

During the entire assembly process, observe HIGH CURRENT MICRO FUSE body temperature and the heating time specified in the performance table. In addition, observe the following items :

- (1) Mounting and adjusting with soldering irons are not recommendable since temperature and time control is difficult.
- (2) Once HIGH CURRENT MICRO FUSE mounted on the board, they should never be remounted on boards or substrates.
- (3) During mounting, be careful not to apply any excessive mechanical stresses to the HIGH CURRENT MICRO FUSE.

3. Solvents

HIGH CURRENT MICRO FUSE has no effect when immersed in isopropyl alcohol for 90 seconds (at 20 ~ 30°C liquid temp.)

If organic solvents will be used to HIGH CURRENT MICRO FUSE, be sure to preliminarily check that the solvent will not damage HIGH CURRENT MICRO FUSE.

4. Ultrasonic Cleaning

Ultrasonic cleaning is not recommended for HIGH CURRENT MICRO FUSE. This may cause damage to HIGH CURRENT MICRO FUSE such as broken terminals which results in electrical characteristics effects, etc. depending on the conditions.

5. Caution During Usage

- (1) HIGH CURRENT MICRO FUSE with electricity should never be touched.
HIGH CURRENT MICRO FUSE with electricity may cause burning due to HIGH CURRENT MICRO FUSE high temperature.
Also, in case of touching HIGH CURRENT MICRO FUSE without electricity, please check the safety temperature of HIGH CURRENT MICRO FUSE.
- (2) Protective eye glasses should always be worn when performing fusing tests.
However, there is a fear that HIGH CURRENT MICRO FUSE will explode during test.
During fusing tests, please cover particles not to fly outward from the board or testing fixture. Caution is necessary during usage at all times.

6. Environmental Conditions

- (1) HIGH CURRENT MICRO FUSE should not be stored or operated in the presence of acids, or alkalis, or corrosive atmosphere.
- (2) HIGH CURRENT MICRO FUSE should not be vibrated, shocked, or pressed excessively.
- (3) HIGH CURRENT MICRO FUSE should not be operated in a flammable or explosive atmosphere.
- (4) HIGH CURRENT MICRO FUSE should not be used under dew condensation environment.
- (5) Covering HIGH CURRENT MICRO FUSE with resin after mounting it on the board may affect the electrical characteristics, so perform thorough evaluation in advance.

7. Emergency

In case of fire, smoking, or offensive odor during operation, please cut off the power in the circuit or pull the plug out.

8. Storage

- (1) HIGH CURRENT MICRO FUSE should not be stored in an environment with high temperature, low temperature, high humidity, condensation and dust and avoid direct sunlight.
HIGH CURRENT MICRO FUSE should not be stored in corrosive atmosphere such as H₂S (hydrogen sulfide) or SO₂ (sulfur dioxide).
Direct sunlight may cause decolorization and deformation of the exterior and taping.
Also, there is a fear that solderability will be remarkably lower in high humidity.
- (2) If the products are stored for an extended period of time, please contact Matsuo Sales Department for recommendation. The longer storage term causes packages and tapings to worsen. If the products are stored for longer term, please contact Matsuo Sales Department for advice.
- (3) The products in taping, package, or box should not be given any kind of physical pressure. Deformation of taping or package may affect automatic mounting.
- (4) The plastic reel (made of PS) used for packaging the product is intended for use in ambient temperatures (5-35°C). To prevent issues during automated insertion due to reel deformation or other factors, please keep the reel away from direct sunlight and heat sources, and ensure it does not reach high temperatures (above 60°C), including during transportation.

9. Disposal

When HIGH CURRENT MICRO FUSE are disposed of as waste or "scrap", they should be treated as "industrial waste".

10. Samples

HIGH CURRENT MICRO FUSE received as samples should not be used in production applications. A sample is provided for the special use (in such cases as the one for the form sample, the electric characteristic confirmation)



MATSUO ELECTRIC CO., LTD.

Please feel free to ask our Sales Department for more information on Micro Fuse.

Overseas Sales 5-3,3-Chome, Sennari-cho, Toyonaka-shi, Osaka 561-8558, Japan Tel:06-6332-0883 Fax:06-6332-0920
Head office 5-3,3-Chome, Sennari-cho, Toyonaka-shi, Osaka 561-8558, Japan Tel:06-6332-0871 Fax:06-6331-1386
URL <https://www.ncc-matsuo.co.jp/>

Specifications on this catalog are subject to change without prior notice. Please inquire of our Sales Department to confirm specifications prior to use.

適用用途分類 / APPLICATION CLASSIFICATION BY USE

Rev.6 (2023.03.01)

市場	適用用途分類	用途		推奨品種	推奨品種	推奨品種	推奨品種
		概要	代表的なアプリケーション例	チップタンタルコンデンサ	リード付タンタルコンデンサ	回路保護素子	フィルムコンデンサ
高信頼度機器	1	<ul style="list-style-type: none"> 高度な安全性や信頼性が要求される機器 製品の保守交換が不可能な機器、製品の故障が人命に直接かわる、または、致命的なシステムダウンを引き起こす可能性がある機器 	<ul style="list-style-type: none"> 宇宙開発機器関連(衛星、ロケット、人工衛星) 航空・防衛システム 原子力・火力・水力発電システム 	267型Pシリーズ	111型Pシリーズ	該当なし	該当なし
車載・産業機器	2	<ul style="list-style-type: none"> 信頼性が重視される機器 製品の保守交換が極めて困難な機器や、製品の故障が人命に影響する、あるいは故障の範囲が広範囲である機器 	<ul style="list-style-type: none"> 自動車および鉄道・船舶等の輸送機器の車両制御(エンジン制御, 駆動制御, ブレーキ制御) 新幹線・主要幹線の運行制御システム 	267型Nシリーズ 271型Nシリーズ 279型Mシリーズ	111型Nシリーズ 111型Mシリーズ 112型Mシリーズ 204型Nシリーズ 247型	JAG型Nシリーズ JAJ型Nシリーズ JAK型Nシリーズ JHC型Nシリーズ KAB型Nシリーズ KVA型Nシリーズ	431型 431型Aシリーズ 503型 553型 801型 802型
	3	<ul style="list-style-type: none"> 製品の保守交換が可能な機器や、製品の故障が人命に影響しないが故障によるシステムダウンの損失が大きく安全管理が要求される機器 	<ul style="list-style-type: none"> エアコン, カーナビ等の車室内搭載部品, 車載用通信機器 家庭用/ビル用等のセキュリティ管理システム 工業用ロボットや工作機械等の制御機器 	267型Mシリーズ 267型Eシリーズ 281型Mシリーズ TCA型	204型Mシリーズ	KAB型Mシリーズ	
汎用機器	4	<ul style="list-style-type: none"> 最先端技術を積極的に適用する小型・薄型品 製品の保守交換が可能な機器や、製品の故障によるシステムダウンが部分的な機器向けの市場で広く使用されることを想定した製品 	<ul style="list-style-type: none"> スマートフォン, 携帯電話, モバイルPC(タブレット), 電子辞書 デスクトップPC, ノートPC, ホームネットワーク アミューズメント機器(パチンコ, ゲーム機) 	251型Mシリーズ 281型Eシリーズ TCB型		JAE型, JAG型 JAJ型, JAK型 JHC型 KAB型 KAB Tシリーズ KVA型	503型Aシリーズ

Market	Application classification by use	Use		Recommendation Type	Recommendation Type	Recommendation Type	Recommendation Type
		Outline	Typical example of application	Chip Tantalum Capacitors	Leaded Tantalum Capacitors	Circuit Protection Components	Film Capacitors
High reliability apparatus	1	<ul style="list-style-type: none"> Apparatus in which advanced safety and reliability are demanded. Whether failure of the apparatus which cannot maintenance exchange products, and a product is direct for a human life, apparatus which changes or may cause a fatal system failure. 	<ul style="list-style-type: none"> Space development apparatus relation (Satellite, Rocket, Artificial Satellite) Aviation and a defensive system Atomic power, fire power, and a water-power generation system 	Type 267 P Series	Type 111 P series	With no relevance	With no relevance
In-vehicle - Industrial apparatus	2	<ul style="list-style-type: none"> Apparatus in which reliability is important. The apparatus in which maintenance exchange of a product is very difficult, and failure of a product influence a human life, or the range of failure is wide range. 	<ul style="list-style-type: none"> Vehicles control of transport machines, such as a car, and a railroad, a vessel (Engine control, drive control, brake control) The operation control system of the Shinkansen and a main artery 	Type 267 N Series Type 271 N Series Type 279 M Series	Type 111 N series Type 111 M series Type 112 M series Type 204 N series Type 247	Type JAG N series Type JAJ N series Type JAK N series Type JHC N series Type KAB N series Type KVA N series	Type 431 Type 431 A series Type 503 Type 553 Type 801 Type 802
	3	<ul style="list-style-type: none"> Apparatus which can maintenance exchange products, and apparatus in which the loss of the system failure is large although failure of a product does not influence a human life, and maintenance engineering is demanded 	<ul style="list-style-type: none"> Vehicle indoor loading parts, such as an air-conditioner and car navigation, and in-vehicle communication facility Security management system for home/buildings etc. Control apparatus, such as Industrial use robots and a machine tool etc. 	Type 267 M Series Type 267 E Series Type 281 M Series Type TCA	Type 204 M series	Type KAB M series	
Apparatus in general	4	<ul style="list-style-type: none"> The small size and the thin article which applies leading-edge technology positively The product supposing being used widely in the market for the apparatus which can maintenance exchange products, and apparatus with a partial system failure by failure of product. 	<ul style="list-style-type: none"> Smart phone, Mobile phone, Mobile PC (tablet), Electronic dictionary Desktop PC, Notebook PC, Home network Amusement apparatus (Pachinko, Game machine) 	Type 251 M Series Type 281 E Series Type TCB		Type JAE, Type JAG Type JAJ, Type JAK Type JHC Type KAB Type KAB T series Type KVA	Type 503 A series

テーピング数量・リール寸法 Taping Quantity And Carrier Tape Dimensions

チップタンタルコンデンサ Chip Tantalum Capacitors

定格：251型Mシリーズ, TCB型
Type : 251 M Series, TCB

ケース記号 Case Code	ケースサイズ Case size	W (mm)	F (mm)	E (mm)	P ₁ (mm)	P ₂ (mm)	P ₀ (mm)	φD ₀ (mm)	包装数/リール(個) Quantity/Reel (pcs)	
									φ180	φ330
U	1.0×0.5	8.0±0.3	3.5±0.05	1.75±0.1	2.0±0.05	2.0±0.05	4.0±0.1	1.55±0.03	10,000	
M	1.6×0.8				4.0±0.1				4,000 / 3,000 ^{*1}	
S	2.0×1.25								3,000	
A	3.2×1.6									

※1. 251型500規格及びTCB型50規格は3000個/リール
Quantity per reel of Type 251 Specification Number 500 and Type TCB Specification Number 50 is 3000.

定格：267型Mシリーズ, 267型Eシリーズ, 267型Pシリーズ, 271Nシリーズ
279型Mシリーズ, 281型Mシリーズ, 281型Eシリーズ
Type : 267 M Series, 267 E Series, 267 P Series, 271 N Series
279 M Series, 281 M Series, 281 E Series

ケース記号 Case Code	ケースサイズ Case size	W (mm)	F (mm)	E (mm)	P ₁ (mm)	P ₂ (mm)	P ₀ (mm)	D ₀ (mm)	包装数/リール(個) Quantity/Reel (pcs)	
									φ180	φ330
A	3.2×1.6	8.0±0.3	3.5±0.05	1.75±0.1	4.0±0.1	2.0±0.05	4.0±0.1	φ1.5 ^{+0.1} ₀	2,000	9,000
B	3.5×2.8								8,000	
C3	6.0×3.2	12.0±0.3	5.5±0.05	1.5±0.1	8.0±0.1				500	3,000
D3	7.3×4.4		5.7±0.05							2,500
H	7.3×4.4		5.7±0.1	1,500						
E	7.3×5.8	5.5±0.05	1.75±0.05				2,000			

定格：267型Nシリーズ, TCA型
Type : 267 N Series, TCA

ケース記号 Case Code	ケースサイズ Case size	W (mm)	F (mm)	E (mm)	P ₁ (mm)	P ₂ (mm)	P ₀ (mm)	D ₀ (mm)	包装数/リール(個) Quantity/Reel (pcs)	
									φ180	φ330
A	3.2×1.6	8.0±0.3	3.5±0.05	1.75±0.1	4.0±0.1	2.0±0.05	4.0±0.1	φ1.5 ^{+0.1} ₀	2,000	9,000
B	3.5×2.8								8,000	
C	6.0×3.2	12.0±0.3	5.5±0.05	1.5±0.1	8.0±0.1				500	3,000
D	7.3×4.4		5.7±0.05							2,500

回路保護素子 Circuit Protection Components

定格：JAE型, JAG型, JAG型Nシリーズ, JAJ型, JAJ型Nシリーズ, JAK型, JAK型Nシリーズ, JHC型, JHC型Nシリーズ
KAB型, KAB型Nシリーズ, KAB型Mシリーズ, KAB型Tシリーズ, KVA型, KVA型Nシリーズ
Type : JAE, JAG, JAG N Series, JAJ, JAJ N Series, JAK, JAK N Series, JHC, JHC N Series
KAB, KAB N Series, KAB M Series, KAB T Series, KVA, KVA N Series

ケース記号 Case Code	ケースサイズ Case size	W (mm)	F (mm)	E (mm)	P ₁ (mm)	P ₂ (mm)	P ₀ (mm)	D ₀ (mm)	包装数/リール(個) Quantity/Reel (pcs)	
									φ180	φ330
29	1.6×0.8	8.0±0.3	3.5±0.05	1.75±0.05	4.0±0.1	2.0±0.05	4.0±0.1	φ1.55±0.03	5,000	-
31	2.0×1.25								-	
52	3.2×1.6			2,000	-					
44E	7.3×5.8	12±0.3	5.5±0.05	1.75±0.1	8.0±0.1				500	1,500
59F	11.0×7.3	24±0.3	11.5±0.05		12.0±0.1	-	500			

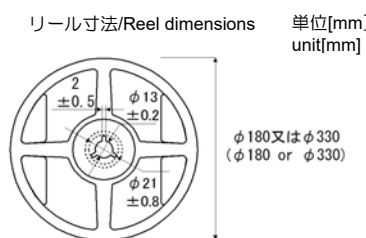
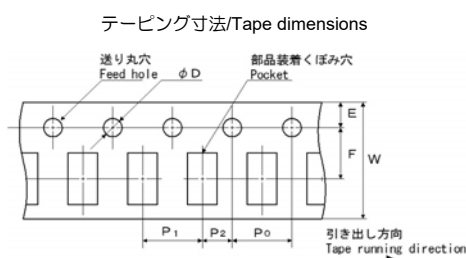

チップタンタルコンデンサ テーピング形状記号
Chip Tantalum Capacitors Tape code

φ180リール φ180Reel	φ330リール φ330Reel	極性 Anode notation
L	P	送り穴側 + Feed hole +
R	N	送り穴側 - Feed hole -