

No. P-267N-E010
DATE 2023-09

PRODUCTS DATA SHEET

AEC-Q200 Compliant

TANTALUM SOLID ELECTROLYTIC CAPACITOR

Type 267 N Series

RoHS COMPLIANT
LEAD FREE

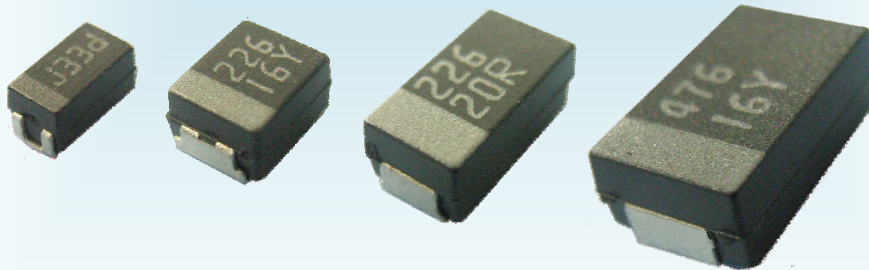

MATSUO ELECTRIC CO., LTD.

Type267 NSeries (AEC-Q200 compliant)

Type 267 NSeries is specially designed to SMD, based on our technology of chip tantalum capacitors acquired over many years. Fully-molded construction provides excellent mechanical protection, superior moisture resistance and high soldering heat resistance. This series is high-reliability capacitors developed for devices, such as automotive electric components, to be used under severe environmental conditions.

FEATURES

1. Suitable for automotive electronics, such as Engine Control Units, ABS, Air Bags, and etc.
2. AEC-Q200 compliant
3. Lead-free and RoHS compliant

APPLICATION CLASSIFICATION BY USE

The application classification by use which divided the market and use into four is set up supposing our products being used for a broad use.

Please confirm the application classification by use of each product that you intend to use.

Moreover, please be sure to inform to our Sales Department in advance in examination of the use of those other than the indicated use.

RATING

Item	Rating	Remarks
Category Temperature Range (Operating Temperature Range)	-55 ~ +125°C	To be used at derated voltage when temperature exceeds 85°C (At 125°C, 2/3 × rated voltage)
Rated Temperature (Max. Operating Temp, at Rated Voltage)	+85°C	
Rated Voltage	4 ~ 35VDC	See CATALOG NUMBERS AND RATING OF STANDARD PRODUCTS
Nominal Capacitance	0.1 ~ 220 μF	
Nominal Capacitance Tolerance	±20%, ±10%	

ORDERING INFORMATION

267 TYPE		N SERIES		1002 RATED VOLTAGE		226 Nominal CAPACITANCE		M CAPACITANCE TOLERANCE		R STYLE OF REELED PACKAGE (Taping specification)			C CASE CODE	
Marking	Rated Voltage	Marking	Rated Voltage	Marking	Rated Voltage	Capacitance Tolerance	Marking	Code	Reel Size	Anode Notation	Case Code	Case Size		
4001	4DVC	104	0.1 μF	685	6.8 μF	±10%	K	L	φ 180 Reel	Feed hole: +	A	3216		
6301	6.3DVC	154	0.15 μF	106	10 μF	±20%	M	R	φ 180 Reel	Feed hole: -	B	3528		
1002	10VDC	224	0.22 μF	156	15 μF			P	φ 330 Reel	Feed hole: +	C	6032		
1602	16VDC	334	0.33 μF	226	22 μF			N	φ 330 Reel	Feed hole: -	D	7343		
2002	20VDC	474	0.47 μF	336	33 μF									
2502	25VDC	684	0.68 μF	476	47 μF									
3502	35VDC	105	1.0 μF	686	68 μF									
		155	1.5 μF	107	100 μF									
		225	2.2 μF	157	150 μF									
		335	3.3 μF	227	220 μF									
		475	4.7 μF											

DIMENSIONS

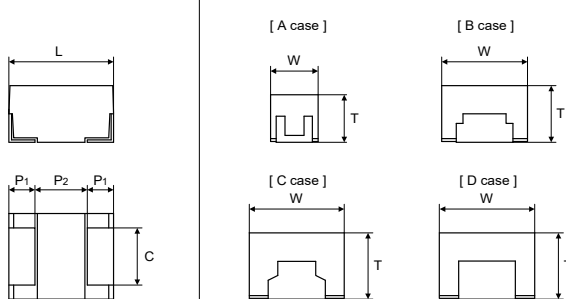

Case Code	Case Size	L±0.2	W±0.2	T±0.2	P ₁ ±0.2	P ₂ min.	C±0.1
A	3216	3.2	1.6	1.6	0.75	1.4	1.2
B	3528	3.5	2.8	1.9	0.8	1.5	2.2
C	6032	6.0	3.2	2.5	1.3	3.0	2.2
D	7343	7.3	4.4	2.8	1.3	4.0	2.4

MARKING

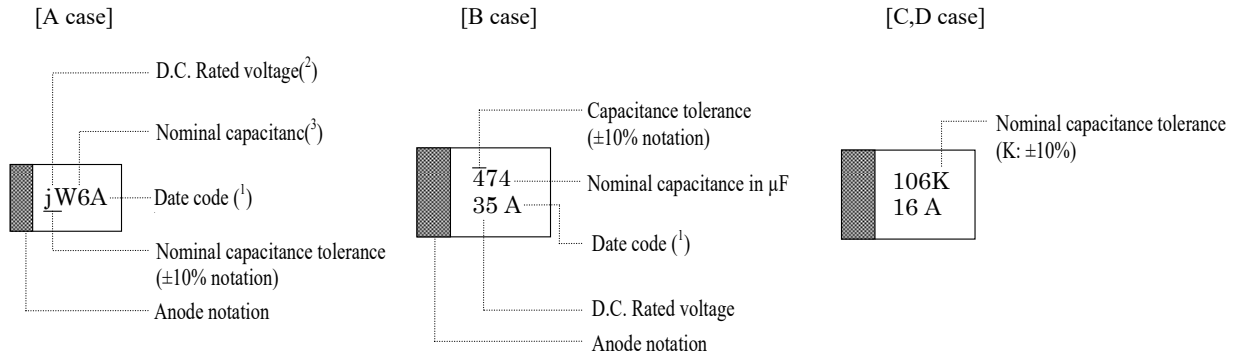

Note⁽¹⁾ Product date sign is shown in accordance with appendix 1 table 13 of JIS C 5101-1

⁽²⁾ Rated voltage of A case size is shown below in accordance with appendix 1 table 9 of JIS C 5101-1

Rated voltage	4	6.3	10	16	20	25	35
code	g	j	A	C	D	E	V

⁽³⁾ Nominal capacitance of A case size is shown below, with 1 Alphabet character and 1 number, in accordance with appendix 1 table 10 and appendix 1 table 11 of JIS C 5101-1

Capacitance (μF)	0.1	0.15	0.22	0.33	0.47	0.68
code	A5	E5	J5	N5	S5	W5
Capacitance (μF)	1.0	1.5	2.2	3.3	4.7	6.8
code	A6	E6	J6	N6	S6	W6
Capacitance (μF)	10	15	22	33	47	68
code	A7	E7	J7	N7	S7	W7

RECOMMENDED SOLDER PAD LAYOUT

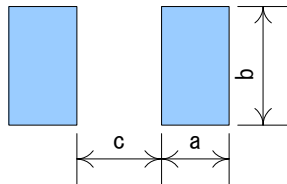

Case Code	Case Size	a		b	c
		Flow	Reflow		
A	3216	3.0	2.0	1.5	1.5
B	3528	3.2	2.0	2.4	1.8
C	6032	4.2	2.4	2.5	3.3
D	7343	5.2	2.4	2.7	4.6

In order to expect the self alignment effect, it is recommended that the land width is almost the same size as terminal of capacitor, and space between lands(c) nearly equal to the space between terminals for appropriate soldering.

STANDARD RATING

Mar., 2022

R.V.(VDC) Cap.(mF)	4	6.3	10	16	20	25	35
0.1							A
0.15							A
0.22							A
0.33							A
0.47						A	A,B
0.68					A	A	A,B
1				A	A	A	A,B
1.5				A	A	A,B	A,B
2.2				A	A,B	A,B	B,C
3.3			A	A,B	A,B	B	B,C
4.7		A	A	A,B	A,B	B,C	C
6.8	A	A	A,B	A,B	B,C	C	C,D
10	A	A,B	A,B	A,B	B,C	C,D	
15	A	A,B	A,B	A,B,C	C	C	
22	B	A,B	A,B,C	B	C,D	D	
33	B	A,B	B	B,C,D	D		
47		B	B,D	C,D			
68			D	C			
100		B	C	D			
150		C	D				
220			D				

Catalog number ⁽¹⁾ (²)	Rated Voltage (VDC)	Capacitance (μF)	Case Code	Lct. (μA)			Max. Dissipation Factor				ESR Ω 100 kHz
				-55°C 20°C	85°C	125°C	-55°C	20°C	85°C	125°C	
267N 4001 685 ₁₋₂ A	4	6.8	A	0.5	5	6.3	0.08	0.06	0.06	0.08	7.2
267N 4001 106 ₁₋₂ A	↓	10	A	0.5	5	6.3	0.08	0.06	0.06	0.08	7.2
267N 4001 156 ₁₋₂ A	↓	15	A	0.6	6	7.5	0.20	0.12	0.12	0.14	7.1
267N 4001 226 ₁₋₂ B	↓	22	B	0.9	9	11	0.08	0.06	0.06	0.08	2.8
267N 4001 336 ₁₋₂ B	↓	33	B	1.3	13	17	0.08	0.06	0.06	0.08	2.8
267N 6301 475 ₁₋₂ A	6.3	4.7	A	0.5	5	6.3	0.08	0.06	0.06	0.08	7.2
267N 6301 685 ₁₋₂ A	↓	6.8	A	0.5	5	6.3	0.08	0.06	0.06	0.08	7.2
267N 6301 106 ₁₋₂ A	↓	10	A	0.6	6	7.9	0.14	0.10	0.10	0.12	7.1
267N 6301 106 ₁₋₂ B	↓	10	B	0.6	6	7.9	0.08	0.06	0.06	0.06	2.9
267N 6301 156 ₁₋₂ A	↓	15	A	0.9	9	12	0.20	0.12	0.12	0.14	7.1
267N 6301 156 ₁₋₂ B	↓	15	B	0.9	9	12	0.08	0.06	0.06	0.08	2.8
267N 6301 226 ₁₋₂ A	↓	22	A	1.4	14	17	0.20	0.12	0.12	0.14	7.1
267N 6301 226 ₁₋₂ B	↓	22	B	1.4	14	17	0.08	0.06	0.06	0.08	2.8
267N 6301 336 ₁₋₂ A	↓	33	A	2.1	21	26	0.20	0.12	0.12	0.14	7.1
267N 6301 336 ₁₋₂ B	↓	33	B	2.1	21	26	0.14	0.10	0.10	0.12	2.7
267N 6301 476 ₁₋₂ B	↓	47	B	3.0	30	37	0.14	0.10	0.10	0.12	2.7
267N 6301 107 ₁₋₂ B	↓	100	B	6.3	63	79	0.22	0.12	0.12	0.14	2.7
267N 6301 157 ₁₋₂ C	↓	150	C	9.5	95	118	0.18	0.10	0.10	0.12	0.95
267N 1002 335 ₁₋₂ A	10	3.3	A	0.5	5	6.3	0.08	0.06	0.06	0.08	7.2
267N 1002 475 ₁₋₂ A	↓	4.7	A	0.5	5	6.3	0.10	0.06	0.08	0.10	7.2
267N 1002 685 ₁₋₂ A	↓	6.8	A	0.7	7	8.5	0.12	0.10	0.10	0.12	7.1
267N 1002 685 ₁₋₂ B	↓	6.8	B	0.7	7	8.5	0.08	0.06	0.06	0.06	2.9
267N 1002 106 ₁₋₂ A	↓	10	A	1.0	10	13	0.14	0.10	0.10	0.12	7.1
267N 1002 106 ₁₋₂ B	↓	10	B	1.0	10	13	0.08	0.06	0.06	0.08	2.9
267N 1002 156 ₁₋₂ A	↓	15	A	1.5	15	19	0.20	0.12	0.12	0.14	7.1
267N 1002 156 ₁₋₂ B	↓	15	B	1.5	15	19	0.08	0.06	0.06	0.08	2.8
267N 1002 226 ₁₋₂ A	↓	22	A	2.2	22	28	0.20	0.12	0.12	0.14	7.1
267N 1002 226 ₁₋₂ B	↓	22	B	2.2	22	28	0.14	0.10	0.10	0.12	2.8
267N 1002 226 ₁₋₂ C	↓	22	C	2.2	22	28	0.08	0.06	0.06	0.06	0.55
267N 1002 336 ₁₋₂ B	↓	33	B	3.3	33	41	0.14	0.10	0.10	0.12	2.7
267N 1002 476 ₁₋₂ B	↓	47	B	4.7	47	59	0.16	0.12	0.12	0.14	2.7
267N 1002 476 ₁₋₂ D	↓	47	D	4.7	47	59	0.08	0.06	0.06	0.06	0.95
267N 1002 686 ₁₋₂ D	↓	68	D	6.8	68	85	0.08	0.06	0.06	0.08	0.45
267N 1002 107 ₁₋₂ C	↓	100	C	10	100	125	0.12	0.10	0.10	0.12	0.95
267N 1002 157 ₁₋₂ D	↓	150	D	15	150	188	0.15	0.10	0.10	0.12	0.45
267N 1002 227 ₁₋₂ D	↓	220	D	22	220	275	0.15	0.10	0.10	0.12	0.45
267N 1602 105 ₁₋₂ A	16	1	A	0.5	5	6.3	0.05	0.04	0.04	0.05	7.4
267N 1602 155 ₁₋₂ A	↓	1.5	A	0.5	5	6.3	0.08	0.06	0.06	0.06	7.4
267N 1602 225 ₁₋₂ A	↓	2.2	A	0.5	5	6.3	0.08	0.06	0.06	0.08	7.2
267N 1602 335 ₁₋₂ A	↓	3.3	A	0.5	5	6.3	0.12	0.08	0.08	0.10	7.4
267N 1602 335 ₁₋₂ B	↓	3.3	B	0.5	5	6.3	0.06	0.04	0.04	0.06	2.9
267N 1602 475 ₁₋₂ A	↓	4.7	A	0.8	8	9.4	0.12	0.08	0.08	0.10	7.1
267N 1602 475 ₁₋₂ B	↓	4.7	B	0.8	8	9.4	0.06	0.04	0.04	0.06	2.9
267N 1602 685 ₁₋₂ A	↓	6.8	A	1.1	11	14	0.12	0.10	0.10	0.12	7.1
267N 1602 685 ₁₋₂ B	↓	6.8	B	1.1	11	14	0.08	0.06	0.06	0.08	2.9
267N 1602 106 ₁₋₂ A	↓	10	A	1.6	16	20	0.14	0.10	0.10	0.12	7.1
267N 1602 106 ₁₋₂ B	↓	10	B	1.6	16	20	0.08	0.06	0.06	0.08	2.9
267N 1602 156 ₁₋₂ A	↓	15	A	2.4	24	30	0.18	0.12	0.12	0.14	3.6
267N 1602 156 ₁₋₂ B	↓	15	B	2.4	24	30	0.14	0.10	0.10	0.12	2.7
267N 1602 156 ₁₋₂ C	↓	15	C	2.4	24	30	0.08	0.06	0.06	0.08	1.17
267N 1602 226 ₁₋₂ B	↓	22	B	3.5	35	44	0.14	0.10	0.10	0.12	2.7
267N 1602 336 ₁₋₂ B	↓	33	B	5.3	53	66	0.14	0.10	0.10	0.12	2.7
267N 1602 336 ₁₋₂ C	↓	33	C	5.3	53	66	0.30	0.18	0.18	0.20	0.95
267N 1602 336 ₁₋₂ D	↓	33	D	5.3	53	66	0.08	0.06	0.06	0.06	0.97
267N 1602 476 ₁₋₂ C	↓	47	C	7.5	75	94	0.30	0.18	0.18	0.20	0.95
267N 1602 476 ₁₋₂ D	↓	47	D	7.5	75	94	0.08	0.06	0.06	0.08	0.45
267N 1602 686 ₁₋₂ C	↓	68	C	11	109	136	0.12	0.10	0.10	0.12	0.95
267N 1602 107 ₁₋₂ D	↓	100	D	16	160	200	0.12	0.10	0.10	0.12	0.45

Catalog number ⁽¹⁾ ⁽²⁾	Rated Voltage (VDC)	Capacitance (µF)	Case Code	Lct. (µA)			Max. Dissipation Factor				ESR Ω 100 kHz
				-55°C 20°C	85°C	125°C	-55°C	20°C	85°C	125°C	
267N 2002 684 _1_2 A	20	0.68	A	0.5	5	6.3	0.05	0.04	0.04	0.05	7.4
267N 2002 105 _1_2 A	↓	1	A	0.5	5	6.3	0.05	0.04	0.04	0.05	7.4
267N 2002 155 _1_2 A	↓	1.5	A	0.5	5	6.3	0.08	0.06	0.06	0.08	7.2
267N 2002 225 _1_2 A	↓	2.2	A	0.5	5	6.3	0.08	0.06	0.06	0.08	7.4
267N 2002 225 _1_2 B	↓	2.2	B	0.5	5	6.3	0.06	0.04	0.04	0.06	2.9
267N 2002 335 _1_2 A	↓	3.3	A	0.7	7	8.3	0.12	0.08	0.08	0.10	7.1
267N 2002 335 _1_2 B	↓	3.3	B	0.7	7	8.3	0.08	0.06	0.06	0.06	2.9
267N 2002 475 _1_2 A	↓	4.7	A	0.9	9	12	0.10	0.06	0.08	0.10	7.1
267N 2002 475 _1_2 B	↓	4.7	B	0.9	9	12	0.08	0.06	0.06	0.08	2.9
267N 2002 685 _1_2 B	↓	6.8	B	1.4	14	17	0.08	0.06	0.06	0.08	2.9
267N 2002 685 _1_2 C	↓	6.8	C	1.4	14	17	0.08	0.06	0.06	0.08	1.17
267N 2002 106 _1_2 B	↓	10	B	2.0	20	25	0.12	0.08	0.08	0.10	2.8
267N 2002 106 _1_2 C	↓	10	C	2.0	20	25	0.08	0.06	0.06	0.08	1.17
267N 2002 156 _1_2 C	↓	15	C	3.0	30	38	0.08	0.06	0.06	0.08	1.15
267N 2002 226 _1_2 C	↓	22	C	4.4	44	55	0.08	0.06	0.06	0.08	0.95
267N 2002 226 _1_2 D	↓	22	D	4.4	44	55	0.08	0.06	0.06	0.06	0.97
267N 2002 336 _1_2 D	↓	33	D	6.6	66	83	0.08	0.06	0.06	0.06	0.97
267N 2502 474 _1_2 A	25	0.47	A	0.5	5	6.3	0.05	0.04	0.04	0.05	7.4
267N 2502 684 _1_2 A	↓	0.68	A	0.5	5	6.3	0.05	0.04	0.04	0.05	7.4
267N 2502 105 _1_2 A	↓	1	A	0.5	5	6.3	0.06	0.04	0.04	0.06	7.4
267N 2502 155 _1_2 A	↓	1.5	A	0.5	5	6.3	0.08	0.06	0.06	0.08	7.4
267N 2502 155 _1_2 B	↓	1.5	B	0.5	5	6.3	0.06	0.04	0.04	0.06	2.9
267N 2502 225 _1_2 A	↓	2.2	A	0.6	6	6.9	0.12	0.08	0.08	0.10	7.4
267N 2502 225 _1_2 B	↓	2.2	B	0.6	6	6.9	0.08	0.06	0.06	0.06	2.9
267N 2502 335 _1_2 B	↓	3.3	B	0.8	8	10	0.08	0.06	0.06	0.08	2.9
267N 2502 475 _1_2 B	↓	4.7	B	1.2	12	15	0.08	0.06	0.06	0.08	2.9
267N 2502 475 _1_2 C	↓	4.7	C	1.2	12	15	0.08	0.06	0.06	0.08	1.18
267N 2502 685 _1_2 C	↓	6.8	C	1.7	17	21	0.08	0.06	0.06	0.06	1.17
267N 2502 106 _1_2 C	↓	10	C	2.5	25	31	0.08	0.06	0.06	0.08	1.17
267N 2502 106 _1_2 D	↓	10	D	2.5	25	31	0.08	0.06	0.06	0.08	0.98
267N 2502 156 _1_2 C	↓	15	C	3.7	38	46	0.10	0.08	0.08	0.10	1.3
267N 2502 226 _1_2 D	↓	22	D	5.5	55	69	0.08	0.06	0.06	0.08	0.98
267N 3502 104 _1_2 A	35	0.1	A	0.5	5	6.3	0.05	0.04	0.04	0.05	9.7
267N 3502 154 _1_2 A	↓	0.15	A	0.5	5	6.3	0.05	0.04	0.04	0.05	9.7
267N 3502 224 _1_2 A	↓	0.22	A	0.5	5	6.3	0.05	0.04	0.04	0.05	7.4
267N 3502 334 _1_2 A	↓	0.33	A	0.5	5	6.3	0.05	0.04	0.04	0.05	7.4
267N 3502 474 _1_2 A	↓	0.47	A	0.5	5	6.3	0.05	0.04	0.04	0.05	7.4
267N 3502 474 _1_2 B	↓	0.47	B	0.5	5	6.3	0.05	0.04	0.04	0.05	2.9
267N 3502 684 _1_2 A	↓	0.68	A	0.5	5	6.3	0.06	0.04	0.04	0.06	7.4
267N 3502 684 _1_2 B	↓	0.68	B	0.5	5	6.3	0.05	0.04	0.04	0.05	2.9
267N 3502 105 _1_2 A	↓	1	A	0.5	5	6.3	0.06	0.04	0.04	0.06	7.4
267N 3502 105 _1_2 B	↓	1	B	0.5	5	6.3	0.05	0.04	0.04	0.05	2.9
267N 3502 155 _1_2 A	↓	1.5	A	0.5	5	6.6	0.12	0.08	0.08	0.10	7.1
267N 3502 155 _1_2 B	↓	1.5	B	0.5	5	6.6	0.08	0.06	0.06	0.06	2.9
267N 3502 225 _1_2 B	↓	2.2	B	0.8	8	9.6	0.08	0.06	0.06	0.08	2.9
267N 3502 225 _1_2 C	↓	2.2	C	0.8	8	9.6	0.08	0.06	0.06	0.08	1.18
267N 3502 335 _1_2 B	↓	3.3	B	1.2	12	14	0.08	0.06	0.06	0.08	2.9
267N 3502 335 _1_2 C	↓	3.3	C	1.2	12	14	0.08	0.06	0.06	0.08	1.18
267N 3502 475 _1_2 C	↓	4.7	C	1.6	16	21	0.08	0.06	0.06	0.06	1.17
267N 3502 685 _1_2 C	↓	6.8	C	1.6	16	21	0.08	0.06	0.06	0.08	1.17
267N 3502 685 _1_2 D	↓	6.8	D	2.4	24	30	0.08	0.06	0.06	0.08	0.98

Notes (1) _1 : Permissible tolerance K (±10%) or M (±20%)

(2) _2 : No code for single item. 'R'('N') or 'L'('P') for taping specification

PERFORMANCE

No.	Item	Performance	Test method	
1	Leakage Current (μA)	Shall not exceed 0.01 CV or 0.5 μA whichever is greater.	IEC 60384-1, 4.9 Applied voltage : Rated voltage Duration : 5 min Measuring temperature : Room temperature	
2	Capacitance (μF)	Shall be within tolerance of the nominal value specified.	IEC 60384-1, 4.7 Measuring frequency : 120 Hz \pm 20% Measuring voltage : 0.5 Vrms +1.5 ~ 2 VDC Measuring temperature : Room temperature	
3	Dissipation Factor	Shall not exceed the values shown in CATALOG NUMBERS AND RATING OF STANDARD PRODUCTS .	IEC 60384-1, 4.8 Measuring frequency : 120 Hz \pm 20% Measuring voltage : 0.5 Vrms +1.5 ~ 2 VDC Measuring temperature : Room temperature	
4	Equivalent Series Resistance	Shall not exceed the values shown in CATALOG NUMBERS AND RATING OF STANDARD PRODUCTS .	Measuring frequency : 100 kHz Measuring temperature : Room temperature	
5	Characteristics at High and Low Temperature		IEC 60384-1, 4.29	
	Step 1	Leakage Current Capacitance Dissipation Factor	Shall not exceed the value in No.1. Shall be within tolerance of the nominal value specified. Shall not exceed the values shown in CATALOG NUMBERS AND RATING OF STANDARD PRODUCTS .	Measuring temperature : $20 \pm 2^\circ\text{C}$
	Step 2	Leakage Current Capacitance Change Dissipation Factor	Shall not exceed the values shown in CATALOG NUMBERS AND RATING OF STANDARD PRODUCTS . Shall be within $_{-12}^0$ % of the value at Step 1 Shall not exceed the values shown in CATALOG NUMBERS AND RATING OF STANDARD PRODUCTS .	Measuring temperature : $-55 \pm 3^\circ\text{C}$
	Step 3	Leakage Current Capacitance Change Dissipation Factor	Shall not exceed the value in No.1. Shall be within $\pm 2\%$ of the value at Step 1. Shall not exceed the values shown in CATALOG NUMBERS AND RATING OF STANDARD PRODUCTS.	Measuring temperature : $20 \pm 2^\circ\text{C}$
	Step 4	Leakage Current Capacitance Change Dissipation Factor	Shall not exceed 0.1 CV or 5 μA whichever is greater. Shall be within $_{-10}^{+10}$ % of the value at Step 1 Shall not exceed the values shown in CATALOG NUMBERS AND RATING OF STANDARD PRODUCTS .	Measuring temperature : $85 \pm 2^\circ\text{C}$
	Step 5	Leakage Current Capacitance Change Dissipation Factor	Shall not exceed 0.125CV or 6.3 μA whichever is greater. Shall be within $_{-15}^{+15}$ % of the value at Step 1 Shall not exceed the values shown in CATALOG NUMBERS AND RATING OF STANDARD PRODUCTS.	Measuring temperature : $125 \pm 2^\circ\text{C}$ Measuring voltage : Derated voltage at 125°C
	Step 6	Leakage Current Capacitance Change Dissipation Factor	Shall not exceed the value in No.1. Shall be within $\pm 2\%$ of the value at Step 1. Shall not exceed the values shown in CATALOG NUMBERS AND RATING OF STANDARD PRODUCTS.	Measuring temperature : $20 \pm 2^\circ\text{C}$
6	High Temperature Exposure	Leakage Current Capacitance Change Dissipation Factor Appearance	Shall not exceed 10 times value in No.1 Within $\pm 15\%$ of initial value. Shall not exceed the values shown in CATALOG NUMBERS AND RATING OF STANDARD PRODUCTS. There shall be no evidence of mechanical damage.	MIL-STD-202 Method 108 Temperature : $125 \pm 2^\circ\text{C}$ Duration : 1000_{-0}^{+48} hrs Measurement at 24 ± 4 hours after test Conclusion.
7	Temperature Cycle	Leakage Current Capacitance Change Dissipation Factor Appearance	Shall not exceed 5 times value in No.1 Within $\pm 15\%$ of initial value. Shall not exceed the values shown in CATALOG NUMBERS AND RATING OF STANDARD PRODUCTS. There shall be no evidence of mechanical damage.	JESD22 Method JA-104 Step 1 : $-55 \pm 3^\circ\text{C}$, 30 \pm 3 min. Step 2 : 25_{-5}^{+10} $^\circ\text{C}$, 3 min.max. Step 3 : $125 \pm 2^\circ\text{C}$, 30 \pm 3 min. Step 4 : 25_{-5}^{+10} $^\circ\text{C}$, 3 min.max. Number of cycles : 1000 Measurement at 24 ± 4 hours after test Conclusion.
8	Biased Humidity	Leakage Current Capacitance Change Dissipation Factor Appearance	Shall not exceed 10 times value in No.1 Within $\pm 10\%$ of initial value. Shall not exceed the values shown in CATALOG NUMBERS AND RATING OF STANDARD PRODUCTS. There shall be no evidence of mechanical damage.	MIL-STD-202 Method 103 Temperature : $85 \pm 2^\circ\text{C}$ Moisture : $85 \pm 5\%$ RH Applied voltage : DC rated voltage Duration : 1000_{-0}^{+48} hrs Measurement at 24 ± 4 hours after test Conclusion.
9	Operational Life	Leakage Current Capacitance Change Dissipation Factor Appearance	Shall not exceed 1.25 times value in No.1 Within $\pm 15\%$ of initial value. Shall not exceed the values shown in CATALOG NUMBERS AND RATING OF STANDARD PRODUCTS. There shall be no evidence of mechanical damage.	MIL-STD-202 Method 108 Test temperature : $125 \pm 3^\circ\text{C}$ Applied voltage : DC rated voltage $\times 2/3$ Duration : 2000_{-0}^{+72} hrs Series resistance: do not exceed 3 Ω Measurement at 24 ± 4 hours after test Conclusion.
10	Resistance to Solvents	Leakage Current Capacitance Change Dissipation Factor	Shall not exceed the value in No.1. Shall n Within $\pm 10\%$ of initial value. Shall not exceed the values shown in CATALOG NUMBERS AND RATING OF STANDARD PRODUCTS.	MIL-STD-202 Method 215
11	Mechanical Shock (specified pulse)	Shock	There shall be no intermittent contact of 0.5 ms or greater duration or arcing or other indication of breakdown, nor shall there be any open or short-circuiting or evidence of mechanical damage.	MIL-STD-202 Method 213 Test condition : F Peak value: 1500G Duration : 0.5ms Wave form : Half-sine

No.	Item (1)		Performance	Test method
12	Vibration	Capacitance Appearance	Initial value to remain steady during measurement. There shall be no evidence of mechanical damage.	MIL-STD-202 Method 204 Vibration Amplitude : 5G (peak) Frequency range : 10 ~ 2000 Hz Duration : 20min in each of three mutually perpendicular directions , 12 cycles.
13	Resistance to Soldering Heat	Leakage Current Capacitance Change Dissipation Factor Appearance	Shall not exceed the value in No.1. Shall n Within $\pm 10\%$ of initial value. Shall not exceed the values shown in CATALOG NUMBERS AND RATING OF STANDARD PRODUCTS. There shall be no cracks and other damage.	MIL-STD-202 Method 210 Solder temperature : $260 \pm 5^{\circ}\text{C}$ Duration: 10 ± 1 sec Number of heat cycles : 1
14	ESD		There shall be no evidence of mechanical damage.	AEC-Q200-002 Component classification 1B
15	Solderability	Solder Bath/Dip And Look Test	The dipped portion of the lead shall be covered more than 95% with new solder.	J-STD-002 Solder temperature : $235 \pm 5^{\circ}\text{C}$ Dipping time : 5 ± 0.5 sec Capacitor terminal shall be dipped into melted solder.
		Resistance to Dissolution Metallization Test	Leaching/dewetting shall be no more than 5% of the solderable metallization exhibiting exposed underlying.	J-STD-002 Solder temperature : $260 \pm 5^{\circ}\text{C}$ Dipping time : 30 ± 0.5 sec Capacitor terminal shall be dipped into melted solder.
		Pb-free Solderability Test	Inspect devices at 10x to 20x magnification. The inspected area of each lead must have 95% solder coverage minimum.	JESD22-B102E Steam Precondition : 8 ± 15 min Solder temperature : $245 \pm 5^{\circ}\text{C}$ Dipping time : 5 ± 0.5 sec Capacitor terminal shall be dipped into melted solder.
16	Board Flex (Substrate bending test)	Capacitance Appearance	Capacitance shall be stable during bending position of the substrate. There shall be no evidence of mechanical damage.	AEC-Q200-005 Bend the board : 3 mm Duration : 5s
17	Terminal strength (Shear Test)		No exfoliation between lead terminal and board.	AEC-Q200-006 Applied pressure : 17.7N Duration : 60s
18	Whisker		Shall be satisfied Class2 at JESD201A.	JESD201A

FREQUENCY CHARACTERISTICS

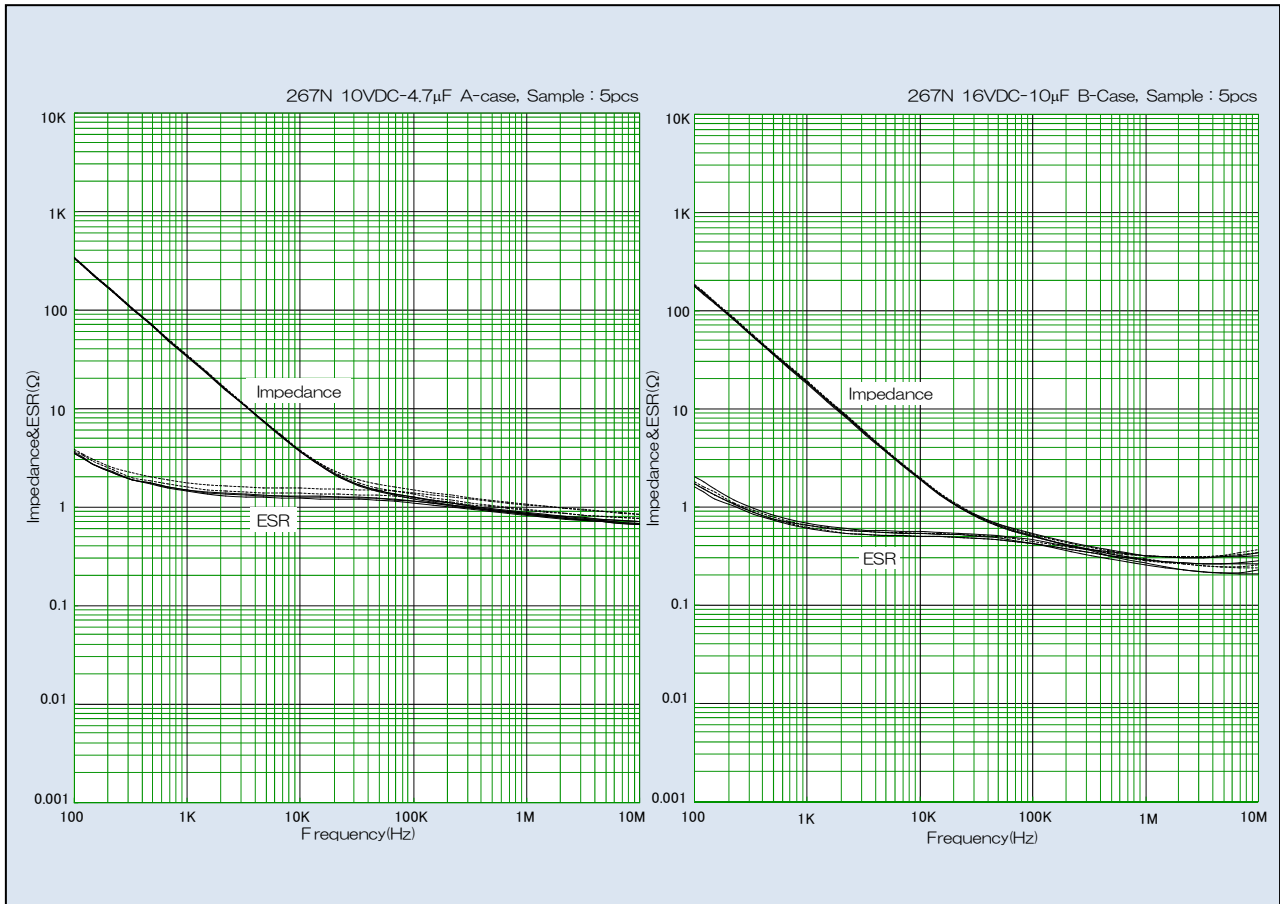

TEMPERATURE CHARACTERISTICS

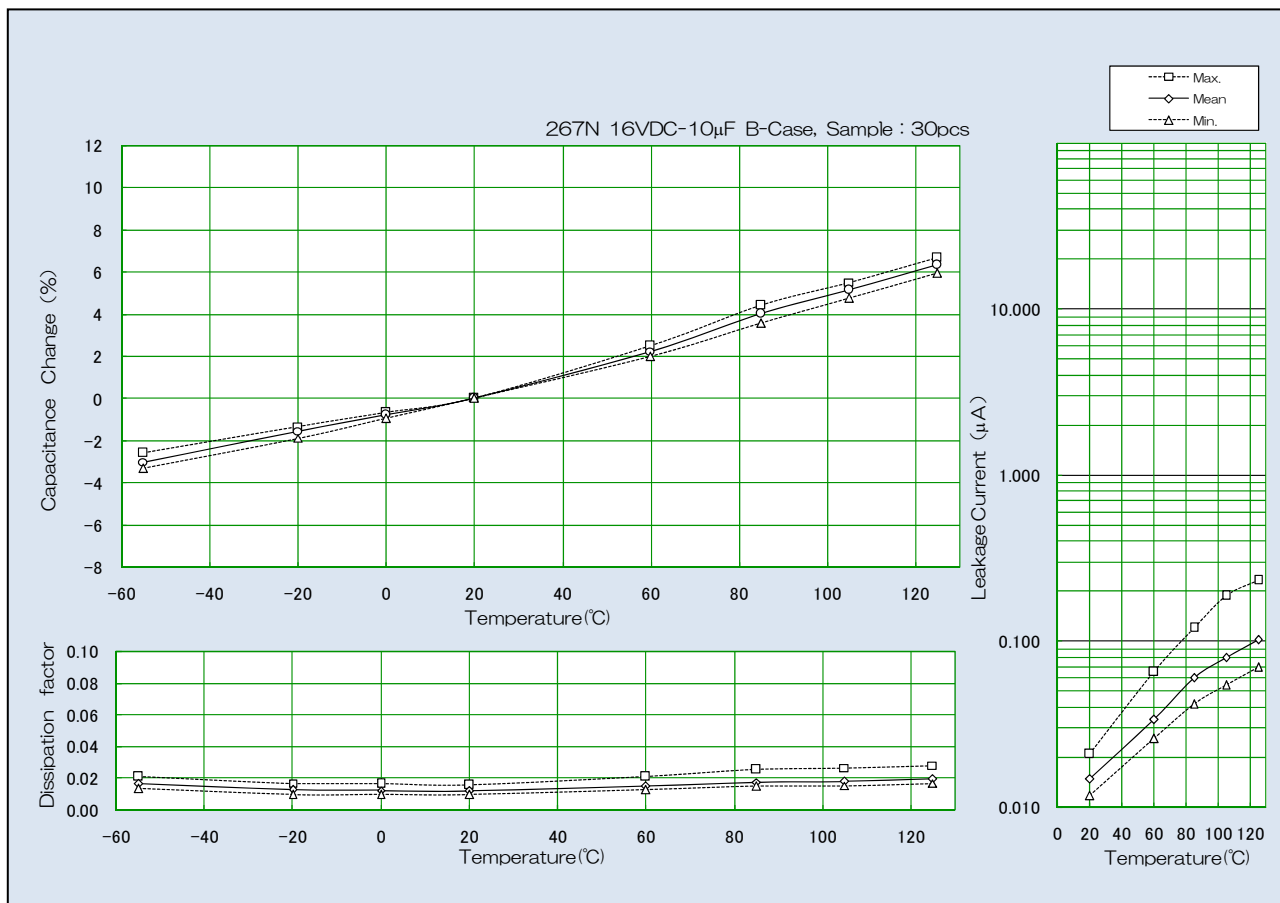

BIASED HUMIDITY 85°C, 85%RH

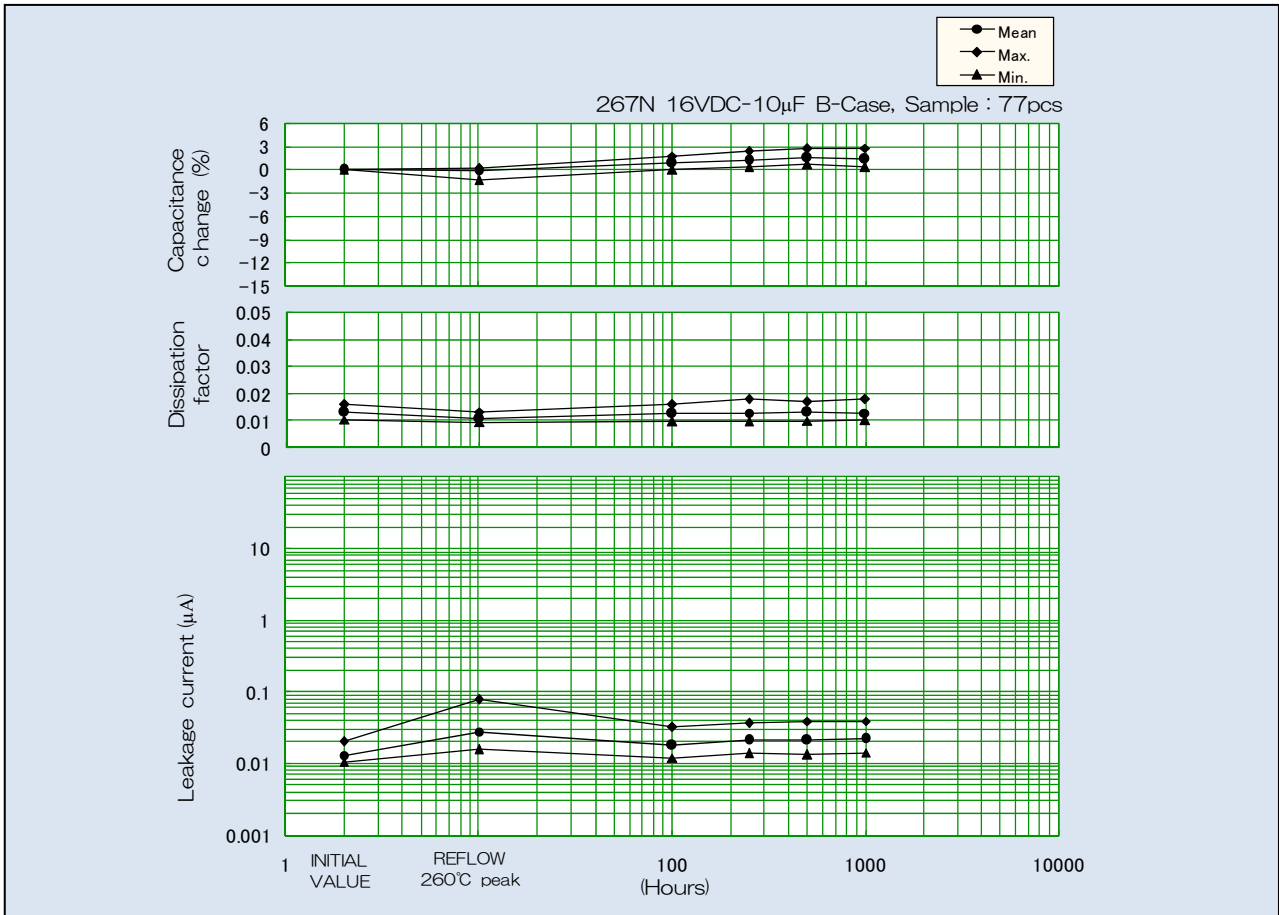

OPERATIONAL LIFE 125°C, RATED VOLTAGE \times 2/3

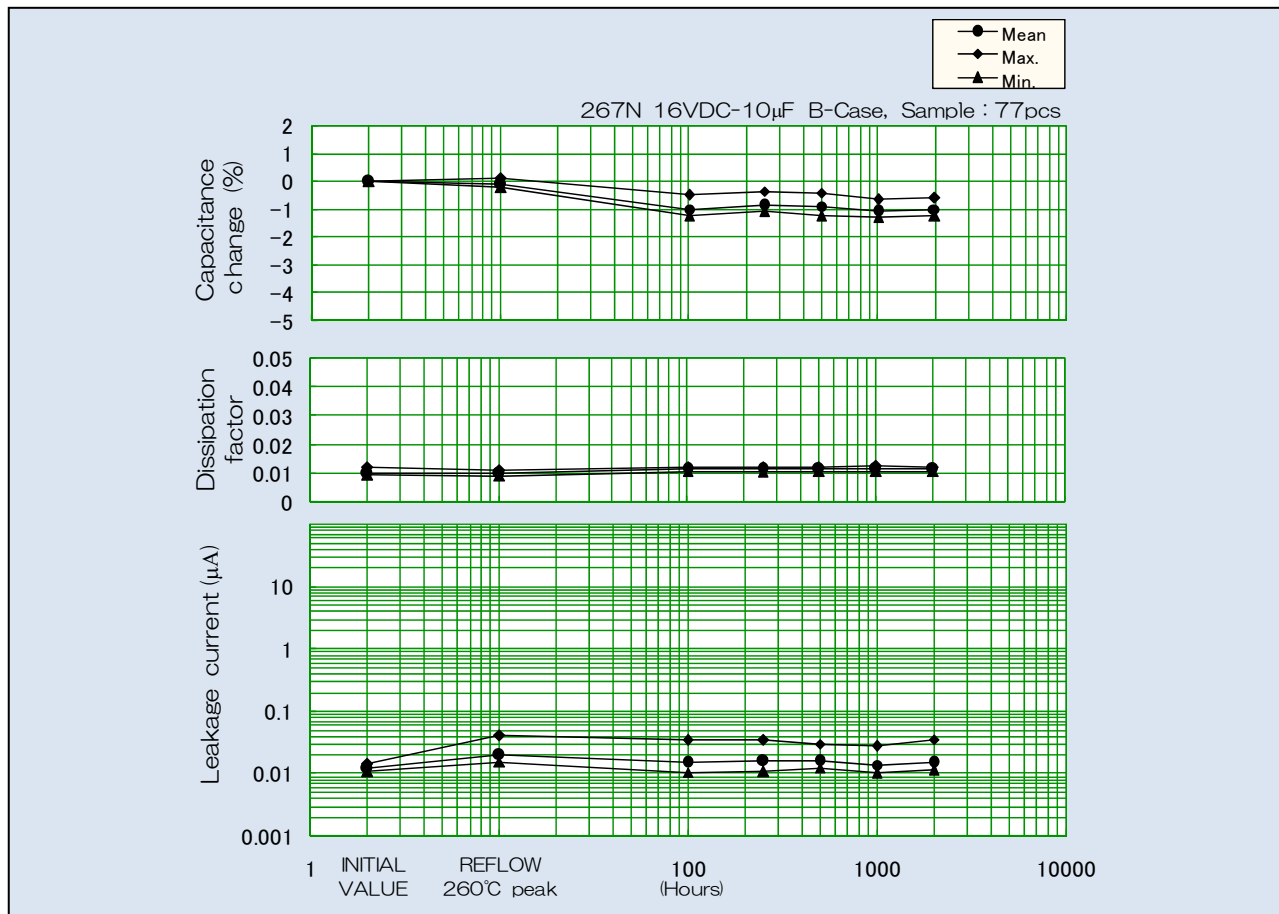



Application Notes for Tantalum Solid Electrolytic Capacitor

1. Operating Voltage

Tantalum Solid Electrolytic Capacitor shall be operated at the rated voltage or lower.

Rated voltage: The "rated voltage" refers to the maximum DC voltage that is allowed to be continuously applied between the capacitor terminals at the rated temperature.

Surge voltage: The "surge voltage" refers to the voltage that is allowed to be instantaneously applied to the capacitor at the rated temperature or the maximum working temperature. The capacitor shall withstand the voltage when a 30-second cycle of application of the voltage through a 1000 Ω series resistance is repeated 1000 times in 6-minute periods.

2. Application that contain AC Voltage

Special attention to the following 3 items.

- (1) The sum of the DC bias voltage and the positive peak value of the AC voltage should not exceed the rated voltage.
- (2) Reverse voltage should not exceed the allowable values of the negative peak AC voltage.
- (3) Ripple current should not exceed the allowable values.

3. Reverse Voltage

Tantalum solid electrolytic capacitor is polarity. Please do not impress reverse voltage. As well, please confirm the potential of the tester beforehand when both ends of the capacitor are checked with the tester etc.

4. Permissible Ripple Current

The permissible ripple current and voltage at about 100 kHz or higher can be determined by the following formula from the permissible power loss (Pmax value) shown in Table 1 and the specified ESR value. However, when the expected operating temperature is higher than room temperature, determine the permissible values multiplying the Pmax value by the specified multiplier (Table 2). For the permissible values at different frequencies, consult our Sales Department.

$$P = I^2 \times ESR \text{ or } P = \frac{E^2 \times ESR}{Z^2}$$

$$\text{Permissible ripple current } I_{max} = \sqrt{\frac{P_{max}}{ESR}} \text{ (Arms)}$$

$$\text{Permissible ripple voltage } E_{max} = \sqrt{\frac{P_{max}}{ESR}} \times Z$$

$$= I_{max} \times Z \text{ (Vrms)}$$

I_{max} : Permissible ripple current at regulated frequency (Arms : RMS value)

E_{max} : Permissible ripple voltage at regulated frequency (Vrms : RMS value)

P_{max} : Permissible power loss (W)

ESR : Specified ESR value at regulated frequency (Ω)

Z : Impedance at regulated frequency (Ω)

Table 1 Permissible power loss

Case Code	Pmax (W)
A	0.045
B	0.050
C	0.065
D	0.085

Table 2 Pmax multiplier at each operating temperature

Operating temperature (°C)	Multiplier
25	1.0
55	0.9
85	0.8
125	0.4

Note: Above values are measured at 0.8t glass epoxy board mounting in free air and may be changed depending on the kind of board, packing density, and air convection condition. Please consult us if calculated power loss value is different from above list of P max value.

5. Application on low-impedance circuit

The failure rate of low impedance circuit at 0.1Ω/V is about five times greater than that of a 1Ω/V circuit. To curtail this higher failure rate, tantalum capacitors used in low impedance circuits, such as filters for power supplies, particularly switching power supplies, or for noise by-passing, require that operating voltage be derated to less than half of the rated voltage. Actually, less than 1/3 of the rated voltage is recommended.

6. Non Polar Application(BACK TO BACK)

The capacitor cannot be used as a non-polar unit.

7. Soldering

7.1. Preheating

To obtain optimal reliability and solderability conditions, capacitors should be pre-heated at 130 to 200 °C for approximately 60 to 120 seconds.

7.2. Soldering

The body of the capacitor shall not exceed 260 °C during soldering.

(1) Reflow Soldering

Reflow soldering is a process in which the capacitors are mounted on a printed board with solder paste. There are two methods of Reflow Soldering: Direct and Atmospheric Heat.

· Direct Heat (Hot plate)

During the Direct Heat method, the capacitor has been positioned on a printed board, which is then placed upon a hot plate.

The capacitor maintains a lower temperature than the substrate, which in turn stays at a lower temperature than the hot plate.

· Atmospheric Heat

a) VPS (Vapor Phase Soldering)

During VPS, the substrate is heated by an inert liquid with a high boiling point. The temperature of the capacitor's body and the temperature of the substrate are about the same as the atmosphere. This temperature should be below 240°C.

b) Near and Far IR Ray

Due to the heat absorption of the capacitor's body, the internal temperature of the capacitors may be 20 ~ 30°C higher than the setting temperature and may exceed 260°C.

Temperature control is crucial in maintaining a temperature of 260 °C or lower.

c) Convection Oven

An infrared ray is the main source of heat in this process. The temperature of the substrate and the capacitors can be maintained at a similar level by the circulation of heated air, or an inert gas.

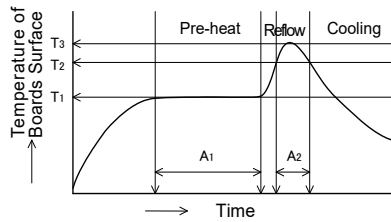

Temperature	Time
T1=130°C~200°C	A1=60~120sec.
T2=220°C~230°C	A2<60秒以下
T3=~260°C	10sec. or less than 10

Number of times: 2 times max.

(2) Soldering with a Soldering Iron

Soldering with a soldering iron cannot be recommended due to the lack of consistency in maintaining temperatures and process times.

If this method should be necessary, the iron should never touch the capacitor's terminals, and the temperature of the soldering iron should never exceed 350°C. The application of the iron should not exceed 5 seconds.

(3) Please consult us for other methods.

8. Cleaning

Cleaning by organic solvent may damage capacitor's appearance and performance. However, our capacitors are not effected even when soaked at 20 ~ 30°C 2-propanol for 5 minutes. When introducing new cleaning methods or changing the cleaning term, please consult us.

9. Protective Resin Coating

After components are assembled to substrate, a protective resin coating is sometimes applied. As this resin coating cures, it gives mechanical and thermal stress to Tantalum capacitors. This stress can cause damage to the capacitors, which affects their reliability.

Before using a resin coating, proper research must be done in regards to the material and process to insure that excessive stress will not be applied to capacitors and other components.

10. Vibration

Approximately 300 G shall be applied to a capacitor, when dropped from 1 meter to a concrete floor.

Although capacitors are made to withstand this drop test, stress from shock due to falling or striking does cause damage to the capacitors and increases failure rates. Do not subject capacitors to this type of mechanical stress.

11. Ultrasonic cleaning

Matsuo does not recommend Ultrasonic cleaning. This may cause damage to the capacitors, and may even cause broken terminals. If the Ultrasonic cleaning process will be used, please note the following:

- (1) The solvent should not be boiled. (Lower the ultrasonic wave output or use solvent with The high boiling point.)
- (2) The recommended wattage is less than 0.5 watts per cm².
- (3) The cleaning time should be kept to a minimum. Also, samples must be swang in the solvent. Please consult us.

12. Additional Notes

- When more than one capacitor is connected in series, a resistor that can distribute the voltage equally to the capacitors shall be connected in parallel.
- The capacitor cases shall not be cut even if the mounting space is insufficient.
- During a customers aging process, voltage should remain under the rated voltage at all times.
- Capacitors should never be touched or manipulated while operating.
- Capacitors are not meant to be dismantled.
- When testing capacitors, please examine the power source before conducting test to insure the tester's polarity and applied voltage.
- In the event of a capacitor burning, smoking, or emitting an offensive smell during operation, please turn the circuit "off" and keep hands and face away from the burning capacitor.
- If a capacitor be electrical shorted, it becomes hot, and the capacitor element may ignite. In this case, the printed board may be burnt out.
- Capacitors should be stored at room temperature under low humidity. Capacitors should never be stored under direct sunlight, and should be stored in an environment containing dust.
- If the capacitors will be operated in a humid environment, they should be sealed with a compound under proper conditions.
- Capacitors should not be stored or operated in environments containing acids, alkalis or active gasses.
- When capacitors are disposed of as "scrap" or waste, they should be treated as Industria Waste since they contain various metals and polymers.
- Capacitors submitted as samples should not be used for production purposes.
- The plastic reel (made of PS) used for packaging the product is intended for use in ambient temperatures (5-35°C). To prevent issues during automated insertion due to reel deformation or other factors, please keep the reel away from direct sunlight and heat sources, and ensure it does not reach high temperatures (above 60°C), including during transportation.

These application notes are prepared based on "Guideline of notabilia for fixed tantalum electrolytic capacitors with solid electrolyte for use in electronic equipment" (RCR-2368) issued by Japan Electronics and Information Technology Industries Association (JEITA).

For the details of the instructions (explanation, reasons and concrete examples), please refer to this guideline, or consult our Sales Department.



MATSUO ELECTRIC CO., LTD.

Please feel free to ask our Sales Department for more information on Tantalum Solid Electrolytic Capacitor.

Overseas Sales 5-3,3-Chome,Sennari-cho,Toyonaka-shi,Osaka 561-8558,Japan Tel:06-6332-0883 Fax:06-6332-0920

Head office 5-3,3-Chome,Sennari-cho,Toyonaka-shi,Osaka 561-8558,Japan Tel:06-6332-0871 Fax:06-6331-1386

URL <https://www.ncc-matsuo.co.jp/>

Specifications on this catalog are subject to change without prior notice. Please inquire of our Sales Department to confirm specifications prior to use.

適用用途分類 / APPLICATION CLASSIFICATION BY USE

Rev.6 (2023.03.01)

市場	適用用途分類	用途		推奨品種	推奨品種	推奨品種	推奨品種
		概要	代表的なアプリケーション例	チップタンタルコンデンサ	リード付タンタルコンデンサ	回路保護素子	フィルムコンデンサ
高信頼度機器	1	<ul style="list-style-type: none"> 高度な安全性や信頼性が要求される機器 製品の保守交換が不可能な機器、製品の故障が人命に直接かわる、または、致命的なシステムダウンを引き起こす可能性がある機器 	<ul style="list-style-type: none"> 宇宙開発機器関連(衛星、ロケット、人工衛星) 航空・防衛システム 原子力・火力・水力発電システム 	267型Pシリーズ	111型Pシリーズ	該当なし	該当なし
車載・産業機器	2	<ul style="list-style-type: none"> 信頼性が重視される機器 製品の保守交換が極めて困難な機器や、製品の故障が人命に影響する、あるいは故障の範囲が広範囲である機器 	<ul style="list-style-type: none"> 自動車および鉄道・船舶等の輸送機器の車両制御(エンジン制御, 駆動制御, ブレーキ制御) 新幹線・主要幹線の運行制御システム 	267型Nシリーズ 271型Nシリーズ 279型Mシリーズ	111型Nシリーズ 111型Mシリーズ 112型Mシリーズ 204型Nシリーズ 247型	JAG型Nシリーズ JAJ型Nシリーズ JAK型Nシリーズ JHC型Nシリーズ KAB型Nシリーズ KVA型Nシリーズ	431型 431型Aシリーズ 503型 553型 801型 802型
	3	<ul style="list-style-type: none"> 製品の保守交換が可能な機器や、製品の故障が人命に影響しないが故障によるシステムダウンの損失が大きく安全管理が要求される機器 	<ul style="list-style-type: none"> エアコン, カーナビ等の車室内搭載部品, 車載用通信機器 家庭用/ビル用等のセキュリティ管理システム 工業用ロボットや工作機械等の制御機器 	267型Mシリーズ 267型Eシリーズ 281型Mシリーズ TCA型	204型Mシリーズ	KAB型Mシリーズ	
汎用機器	4	<ul style="list-style-type: none"> 最先端技術を積極的に適用する小型・薄型品 製品の保守交換が可能な機器や、製品の故障によるシステムダウンが部分的な機器向けの市場で広く使用されることを想定した製品 	<ul style="list-style-type: none"> スマートフォン, 携帯電話, モバイルPC(タブレット), 電子辞書 デスクトップPC, ノートPC, ホームネットワーク アミューズメント機器(パチンコ, ゲーム機) 	251型Mシリーズ 281型Eシリーズ TCB型		JAE型, JAG型 JAJ型, JAK型 JHC型 KAB型 KAB Tシリーズ KVA型	503型Aシリーズ

Market	Application classification by use	Use		Recommendation Type	Recommendation Type	Recommendation Type	Recommendation Type
		Outline	Typical example of application	Chip Tantalum Capacitors	Leaded Tantalum Capacitors	Circuit Protection Components	Film Capacitors
High reliability apparatus	1	<ul style="list-style-type: none"> - Apparatus in which advanced safety and reliability are demanded. - Whether failure of the apparatus which cannot maintenance exchange products, and a product is direct for a human life, apparatus which changes or may cause a fatal system failure. 	<ul style="list-style-type: none"> - Space development apparatus relation (Satellite, Rocket, Artificial Satellite) - Aviation and a defensive system - Atomic power, fire power, and a water-power generation system 	Type 267 P Series	Type 111 P series	With no relevance	With no relevance
In-vehicle - Industrial apparatus	2	<ul style="list-style-type: none"> - Apparatus in which reliability is important. - The apparatus in which maintenance exchange of a product is very difficult, and failure of a product influence a human life, or the range of failure is wide range. 	<ul style="list-style-type: none"> - Vehicles control of transport machines, such as a car, and a railroad, a vessel (Engine control, drive control, brake control) - The operation control system of the Shinkansen and a main artery 	Type 267 N Series Type 271 N Series Type 279 M Series	Type 111 N series Type 111 M series Type 112 M series Type 204 N series Type 247	Type JAG N series Type JAJ N series Type JAK N series Type JHC N series Type KAB N series Type KVA N series	Type 431 Type 431 A series Type 503 Type 553 Type 801 Type 802
	3	<ul style="list-style-type: none"> - Apparatus which can maintenance exchange products, and apparatus in which the loss of the system failure is large although failure of a product does not influence a human life, and maintenance engineering is demanded 	<ul style="list-style-type: none"> - Vehicle indoor loading parts, such as an air-conditioner and car navigation, and in-vehicle communication facility - Security management system for home/buildings etc. - Control apparatus, such as Industrial use robots and a machine tool etc. 	Type 267 M Series Type 267 E Series Type 281 M Series Type TCA	Type 204 M series	Type KAB M series	
Apparatus in general	4	<ul style="list-style-type: none"> - The small size and the thin article which applies leading-edge technology positively - The product supposing being used widely in the market for the apparatus which can maintenance exchange products, and apparatus with a partial system failure by failure of product. 	<ul style="list-style-type: none"> - Smart phone, Mobile phone, Mobile PC (tablet), Electronic dictionary - Desktop PC, Notebook PC, Home network - Amusement apparatus (Pachinko, Game machine) 	Type 251 M Series Type 281 E Series Type TCB		Type JAE, Type JAG Type JAJ, Type JAK Type JHC Type KAB Type KAB T series Type KVA	Type 503 A series

テーピング数量・リール寸法 Taping Quantity And Carrier Tape Dimensions

チップタンタルコンデンサ Chip Tantalum Capacitors

定格：251型Mシリーズ, TCB型
Type : 251 M Series, TCB

ケース記号 Case Code	ケースサイズ Case size	W (mm)	F (mm)	E (mm)	P ₁ (mm)	P ₂ (mm)	P ₀ (mm)	φD ₀ (mm)	包装数/リール(個) Quantity/Reel (pcs)	
									φ180	φ330
U	1.0×0.5	8.0±0.3	3.5±0.05	1.75±0.1	2.0±0.05	2.0±0.05	4.0±0.1	1.55±0.03	10,000	4,000 / 3,000 ^{*1}
M	1.6×0.8				4.0±0.1			1.5 ^{+0.1} ₀		
S	2.0×1.25									
A	3.2×1.6									

※1. 251型500規格及びTCB型50規格は3000個/リール
Quantity per reel of Type 251 Specification Number 500 and Type TCB Specification Number 50 is 3000.

定格：267型Mシリーズ, 267型Eシリーズ, 267型Pシリーズ, 271Nシリーズ
279型Mシリーズ, 281型Mシリーズ, 281型Eシリーズ
Type : 267 M Series, 267 E Series, 267 P Series, 271 N Series
279 M Series, 281 M Series, 281 E Series

ケース記号 Case Code	ケースサイズ Case size	W (mm)	F (mm)	E (mm)	P ₁ (mm)	P ₂ (mm)	P ₀ (mm)	D ₀ (mm)	包装数/リール(個) Quantity/Reel (pcs)	
									φ180	φ330
A	3.2×1.6	8.0±0.3	3.5±0.05	1.75±0.1	4.0±0.1	2.0±0.05	4.0±0.1	φ1.5 ^{+0.1} ₀	2,000	9,000
B	3.5×2.8				8.0±0.1				2,000	8,000
C3	6.0×3.2	12.0±0.3	5.5±0.05	500						
D3	7.3×4.4		5.7±0.05		2,500					
H	7.3×4.4		5.7±0.1			1,500				
E	7.3×5.8	5.5±0.05	1.75±0.05	2,000						

定格：267型Nシリーズ, TCA型
Type : 267 N Series, TCA

ケース記号 Case Code	ケースサイズ Case size	W (mm)	F (mm)	E (mm)	P ₁ (mm)	P ₂ (mm)	P ₀ (mm)	D ₀ (mm)	包装数/リール(個) Quantity/Reel (pcs)	
									φ180	φ330
A	3.2×1.6	8.0±0.3	3.5±0.05	1.75±0.1	4.0±0.1	2.0±0.05	4.0±0.1	φ1.5 ^{+0.1} ₀	2,000	9,000
B	3.5×2.8				8.0±0.1				2,000	8,000
C	6.0×3.2	12.0±0.3	5.5±0.05	500						
D	7.3×4.4		5.7±0.05		1.5±0.1				2,500	

回路保護素子 Circuit Protection Components

定格：JAE型, JAG型, JAG型Nシリーズ, JAJ型, JAJ型Nシリーズ, JAK型, JAK型Nシリーズ, JHC型, JHC型Nシリーズ
KAB型, KAB型Nシリーズ, KAB型Mシリーズ, KAB型Tシリーズ, KVA型, KVA型Nシリーズ
Type : JAE, JAG, JAG N Series, JAJ, JAJ N Series, JAK, JAK N Series, JHC, JHC N Series
KAB, KAB N Series, KAB M Series, KAB T Series, KVA, KVA N Series

ケース記号 Case Code	ケースサイズ Case size	W (mm)	F (mm)	E (mm)	P ₁ (mm)	P ₂ (mm)	P ₀ (mm)	D ₀ (mm)	包装数/リール(個) Quantity/Reel (pcs)	
									φ180	φ330
29	1.6×0.8	8.0±0.3	3.5±0.05	1.75±0.05	4.0±0.1	2.0±0.05	4.0±0.1	φ1.55±0.03	5,000	-
31	2.0×1.25								1.75±0.1	8.0±0.1
52	3.2×1.6			12.0±0.3	5.5±0.05					
44E	7.3×5.8	12±0.3	11.5±0.05						12.0±0.1	-
59F	11.0×7.3	24±0.3	11.5±0.05	12.0±0.1	-	500				

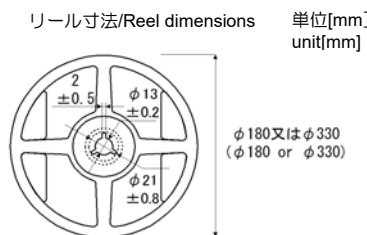
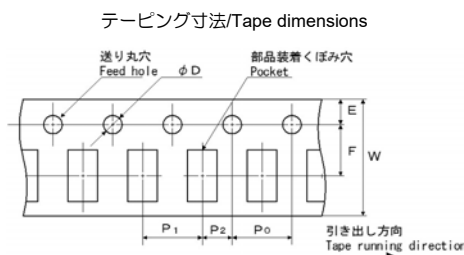

チップタンタルコンデンサ テーピング形状記号
Chip Tantalum Capacitors Tape code

φ180リール φ180Reel	φ330リール φ330Reel	極性 Anode notation
L	P	送り穴側 + Feed hole +
R	N	送り穴側 - Feed hole -