

Type 247 is built-in fuse tantalum solid electrolytic capacitor.

FEATURES

1. With built-in fuse that blows out to prevent smoking and ignition of capacitor when overcurrent flows.
2. Suitable for automatic insertion, as Type 247 has high dimensions precision in the silicone resin molding.
3. RoHS Compliant, Lead-free are available upon request.

RATING

Item	Description
Operating temperature	-55 to +125 °C
Maximum operating temperature for DC rated voltage	+85°C (1)
DC rated voltage range(U_R)	See CATALOG NUMBERS AND RATING OF STANDARD PRODUCTS
Nominal capacitance range(C_R)	
Capacitance tolerance	
Failure rate level	1%/1000h

ORDERING INFORMATION

247 TYPE		M SERIES				1602 RATED VOLTAGE		335 CAPACITANCE		M CAPACITANCE TOLERANCE		B STYLE OF REELED PACKAGE		F LEAD-FREE COMPLIANCE	
Marking	Rated voltage	Marking	Capacitance	Marking	Capacitance	Marking	Capacitance	Marking	Capacitance Tolerance	Marking	Lead style or style of packing	Marking	Lead-free compliance		
6301	6.3VDC	105	1.0 μ F	106	10 μ F	M	\pm 20%	-	Straight Lead	-	Not compliant				
1002	10VDC	155	1.5 μ F	156	15 μ F			B	Ammo Package	E	Inner solder, compliant				
1602	16VDC	225	2.2 μ F	226	22 μ F			C	Reel Package	F	Compliant				
2002	20VDC	335	3.3 μ F	336	33 μ F										
2502	25VDC	475	4.7 μ F	476	47 μ F										
3502	35VDC	685	6.8 μ F												
5002	50VDC														

DIMENSIONS

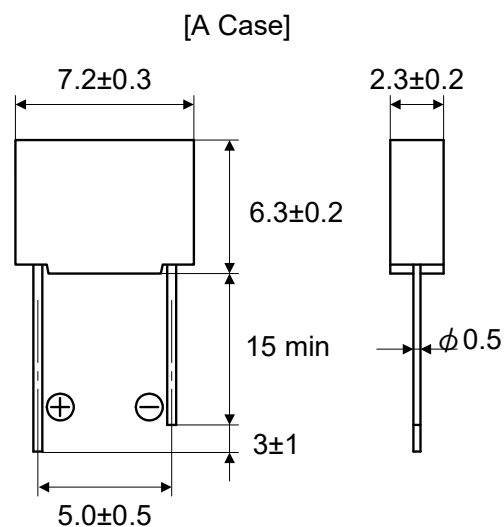

CONSTRUCTION

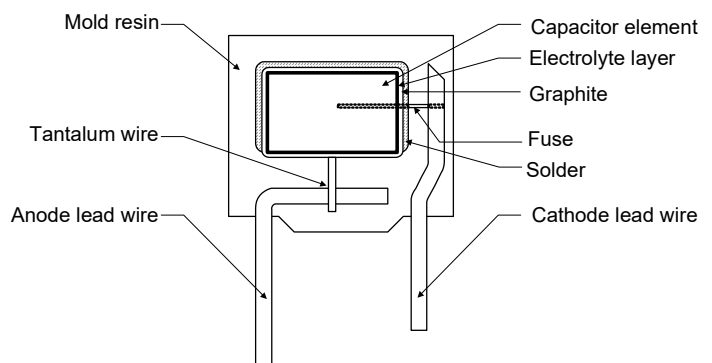

MARKING

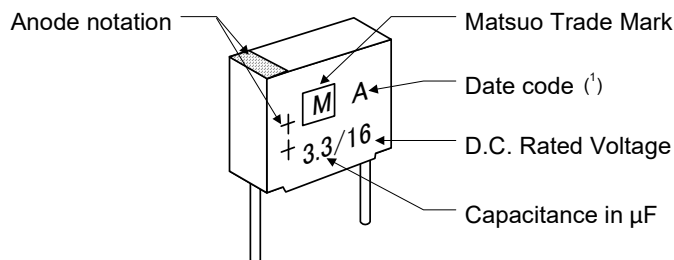

Note(1) Date codes are based on the Annex 1 Table 13 of JIS C 5101-1.

STANDARD RATING

R.V.(VDC) Cap.(μF)	6.3	10	16	20	25	35	50
1.0						A	A
1.5						A	A
2.2						A	A
3.3			A		A	A	A
4.7					A	A	
6.8				A		A	
10			A		A		
15		A		A			
22	A		A				
33		A					
47	A						

CATALOG NUMBERS AND RATING OF STANDARD PRODUCTS

Dec, 2020

Catalog Number (1)(2)	U _R VDC	U _S VDC	C _R μF	Tolerance +/-%	Case code	Leakage current(DCL) μA			Dissipation factor			
						20°C	85°C	125°C	-55°C	20°C	85°C	125°C
247M 6301 226 M ₁ ²	6.3	8	22	20	A	1.4	14	17	0.06	0.06	0.06	0.06
247M 6301 476 M ₁ ²	↓	↓	47	↓	A	3.0	30	37	0.08	↓	↓	0.08
247M 1002 156 M ₁ ²	10	13	15	20	A	1.5	15	19	0.06	0.06	0.06	0.06
247M 1002 336 M ₁ ²	↓	↓	33	↓	A	3.3	33	41	0.08	↓	↓	0.08
247M 1602 335 M ₁ ²	16	20	3.3	20	A	0.5	5	6.3	0.04	0.04	0.04	0.05
247M 1602 106 M ₁ ²	↓	↓	10	↓	A	1.6	16	20	0.06	0.06	0.06	0.06
247M 1602 226 M ₁ ²	↓	↓	22	↓	A	3.5	35	44	0.08	↓	↓	0.08
247M 2002 685 M ₁ ²	20	26	6.8	20	A	1.4	14	17	0.06	0.06	0.06	0.06
247M 2002 156 M ₁ ²	↓	↓	15	↓	A	3.0	30	38	0.08	↓	↓	0.08
247M 2502 335 M ₁ ²	25	32	3.3	20	A	0.8	8	10	0.04	0.04	0.04	0.05
247M 2502 475 M ₁ ²	↓	↓	4.7	↓	A	1.2	12	15	↓	↓	↓	↓
247M 2502 106 M ₁ ²	↓	↓	10	↓	A	2.5	25	31	0.08	0.06	0.06	0.08
247M 3502 105 M ₁ ²	35	44	1.0	20	A	0.5	5	6.3	0.04	0.04	0.04	0.05
247M 3502 155 M ₁ ²	↓	↓	1.5	↓	A	0.5	5	6.6	↓	↓	↓	↓
247M 3502 225 M ₁ ²	↓	↓	2.2	↓	A	0.8	8	9.6	↓	↓	↓	↓
247M 3502 335 M ₁ ²	↓	↓	3.3	↓	A	1.2	12	14	↓	↓	↓	↓
247M 3502 475 M ₁ ²	↓	↓	4.7	↓	A	1.6	16	21	0.08	0.06	0.06	0.08
247M 3502 685 M ₁ ²	↓	↓	6.8	↓	A	2.4	24	30	↓	↓	↓	↓
247M 5002 105 M ₁ ²	50	63	1.0	20	A	0.5	5	6.3	0.04	0.04	0.04	0.05
247M 5002 155 M ₁ ²	↓	↓	1.5	↓	A	0.8	8	9.4	↓	↓	↓	↓
247M 5002 225 M ₁ ²	↓	↓	2.2	↓	A	1.1	11	14	↓	↓	↓	↓
247M 5002 335 M ₁ ²	↓	↓	3.3	↓	A	1.7	17	21	0.08	0.06	0.06	0.08

*U_R = Rated Voltage U_S = Surge Voltage C_R = Capacitance

Note (1): Straight lead style (blank) or packaging style code (B or C).

Note (2): For Lead containing product, insert "blank" into _2

For inner solder lead-free product, insert "E" into _2

For lead-free product, insert "F" into _2

PERFORMANCE

No.	Item		Performance	Test method
1	Leakage Current (μ A)		Shall not exceed 0.01 CV or 0.5 whichever is greater.	JIS C 5101-1, 4.9 Applied Voltage : Rated Voltage for 5 min. Temperature : 20°C
2	Capacitance (μ F)		Shall be within tolerance of the nominal value specified.	JIS C 5101-1, 4.7 Frequency : 120 Hz \pm 20% Voltage : 0.5Vrms+1.5 ~2VDC Temperature : 20°C
3	Dissipation Factor		Shall not exceed the values shown in CATALOG NUMBERS AND RATING OF STANDARD PRODUCTS.	JIS C 5101-1, 4.8 Frequency : 120 Hz \pm 20% Voltage : 0.5Vrms+1.5 ~2VDC Temperature : 20°C
4	Impedance		1.0 Ω max. Note : 16V 3.3 μ F, 35V 1 μ F, 50V 1 μ F Only	JIS C 5101-1, 4.10 Frequency : Resonance Frequency Temperature : 20°C
5	Characteristics at High and Low Temperature			JIS C 5101-1, 4.29
	Step1	Leakage Current	Shall not exceed the value in No.1.	Measuring temperature : 20 \pm 2°C
		Capacitance Dissipation Factor	Shall be within the specified tolerance. Shall not exceed the value in No.3.	
	Step2	Capacitance Change	Shall be within \pm 10% of the value at Step 1.	Measuring temperature : -55 \pm 3 °C
		Dissipation Factor	Shall not exceed the values shown in CATALOG NUMBERS AND RATING OF STANDARD PRODUCTS.	
	Step3	Leakage Current	Shall not exceed the value in No.1.	Measuring temperature : 20 \pm 2°C
		Capacitance Change Dissipation Factor	Shall be within \pm 2% of the value at Step 1. Shall not exceed the value in No.3.	
Step4	Leakage Current	Shall not exceed 0.1 CV or 5 whichever is greater.	Measuring temperature : 85 \pm 2°C	
	Capacitance Change Dissipation Factor	Shall be within \pm 8% of the value at Step 1. Shall not exceed the values shown in CATALOG NUMBERS AND RATING OF STANDARD PRODUCTS.		
Step5	Leakage Current	Shall not exceed 0.125 CV or 6.3 whichever is greater.	Measuring temperature : 125 \pm 2°C Measuring voltage : Derated voltage at 125°C	
	Capacitance Change Dissipation Factor	Shall be within \pm 12% of the value at Step 1. For 50V-3.3 μ F only within \pm 15% of initial value. Shall not exceed the values shown in CATALOG NUMBERS AND RATING OF STANDARD PRODUCTS.		
Step6	Leakage Current	Shall not exceed the value in No.1.	Measuring temperature : 20 \pm 2°C	
	Capacitance Change Dissipation Factor	Shall be within \pm 2% of the value at Step 1. Shall not exceed the value in No.3.		
6	Surge	Leakage Current	Shall not exceed the value in No.1.	JIS C 5101-1, 4.26 Test temperature : 85 \pm 2°C, Applied Voltage :DC surge voltage Series protective resistance : 1000 Ω Discharge resistance : 1000 Ω
		Capacitance Change Dissipation Factor Appearance	Shall be within \pm 5% of the value at Step 1. For 50V-3.3 μ F only within \pm 10% of initial value. Shall not exceed the value in No.3. There shall be no evidence of mechanical damage.	
7	Terminal strength	Tensile strength	No fault such as breakage and loosening terminal	JIS C 5101-1, 4.13.1 Applied force : 5N Duration:10 \pm 1 sec
		Bending strength	No fault such as breakage and loosening terminal	JIS C 5101-1, 4.13.2 Load : 2.5 N Bending cycle:2
8	Vibration	Capacitance Appearance	Initial value to remain steady during measurement. There shall be no evidence of mechanical damage.	JIS C 5101-1, 4.17 Frequency range : 10 ~ 2000 Hz Peak acceleration : 196 m/s ² Vibration direction : 3 directions with mutually right-angled Duration : 2 hours in each of these mutually perpendicular directions (total 6 hours)
9	Shock		There shall be no intermittent contact of 0.5 ms or greater, short, or open. Nor shall there be any spark discharge, insulation breakdown, or evidence of mechanical damage.	JIS C 5101-1, 4.19 Peak acceleration : 981 m/s ² Duration : 6 ms Wave form : Half-sine

No.	Item		Performance	Test method
10	Solderability		Shall be covered to over 3/4 of terminal surface by new soldering.	JIS C 5101-1, 4.15 Solder temperature : 230 ± 5°C Dipping time : 2 ± 0.5 sec Dipping depth : Terminal shall be dipped into melted solder.
11	Resistance to Soldering Heat	Leakage Current Capacitance Change Dissipation Factor Appearance	Shall not exceed the value in No.1. Shall be within ± 3% of the value at Step 1. For 50V-3.3μF only within ±5% of initial value. Shall not exceed the value in No.3. There shall be no evidence of mechanical damage.	JIS C 5101-1, 4.14 Solder temperature: 260 ± 5°C Dipping time: 10 ± 1 sec Dipping depth : Terminal shall be dipped into melted solder.
12	Component solvent resistance	Appearance	There shall be no evidence of mechanical damage.	JIS C 5101-1, 4.31 Temperature : 23 ± 5°C Dipping time : 5 ± 0.5 min. Solvent : 2-propanol (Isopropyl alcohol)
13	Solvent resistance of marking	Visual examination	After the test the marking shall be legible.	JIS C 5101-1, 4.32 Temperature : 23 ± 5°C Dipping time : 5 ± 0.5 min. Solvent : 2-propanol (Isopropyl alcohol)
14	Rapid Change of Temperature	Leakage Current Capacitance Change Dissipation Factor Appearance	Shall not exceed the value in No.1. Shall be within ± 5% of the value at Step 1. For 50V-3.3μF only within ±10% of initial value. Shall not exceed the value in No.3. There shall be no evidence of mechanical damage.	JIS C 5101-1, 4.16 Step 1 : -55 ± 3°C, 30 ± 3 min. Step 2 : 25 ⁺¹⁰ / ₋₅ °C, 3 min. max. Step 3 : 125 ± 2°C, 30 ± 3 min. Step 4 : 25 ⁺¹⁰ / ₋₅ °C, 3 min. max. Number of cycles : 5
15	Damp heat, Steady state	Leakage Current Capacitance Change Dissipation Factor Appearance	Shall not exceed the value in No.1. Shall be within ± 5% of the value at Step 1. For 50V-3.3μF only within ±10% of initial value. Shall not exceed the value in No.3. There shall be no evidence of mechanical damage.	JIS C 5101-1, 4.22 Temperature : 40 ± 2°C Moisture : 90 ~ 95%RH Duration : 500 ⁺²⁴ / ₋₂ hrs
16	Endurance	Leakage Current Capacitance Change Dissipation Factor Appearance	Shall not exceed the value in No.1. Shall be within ± 5% of the value at Step 1. For 50V-3.3μF only within ±10% of initial value. Shall not exceed the value in No.3. There shall be no evidence of mechanical damage.	JIS C 5101-1, 4.23 Test temperature and applied voltage : 85 ± 2°C and rated voltage or 125 ± 3°C and 2/3 × rated voltage Duration : 2000 ⁺⁷² / ₋₂ hrs Power supply impedance : 3 Ω or less
17	Fusing characteristics		Please refer to FUSING CHARACTERISTICS (Reference).	

FREQUENCY CHARACTERISTICS

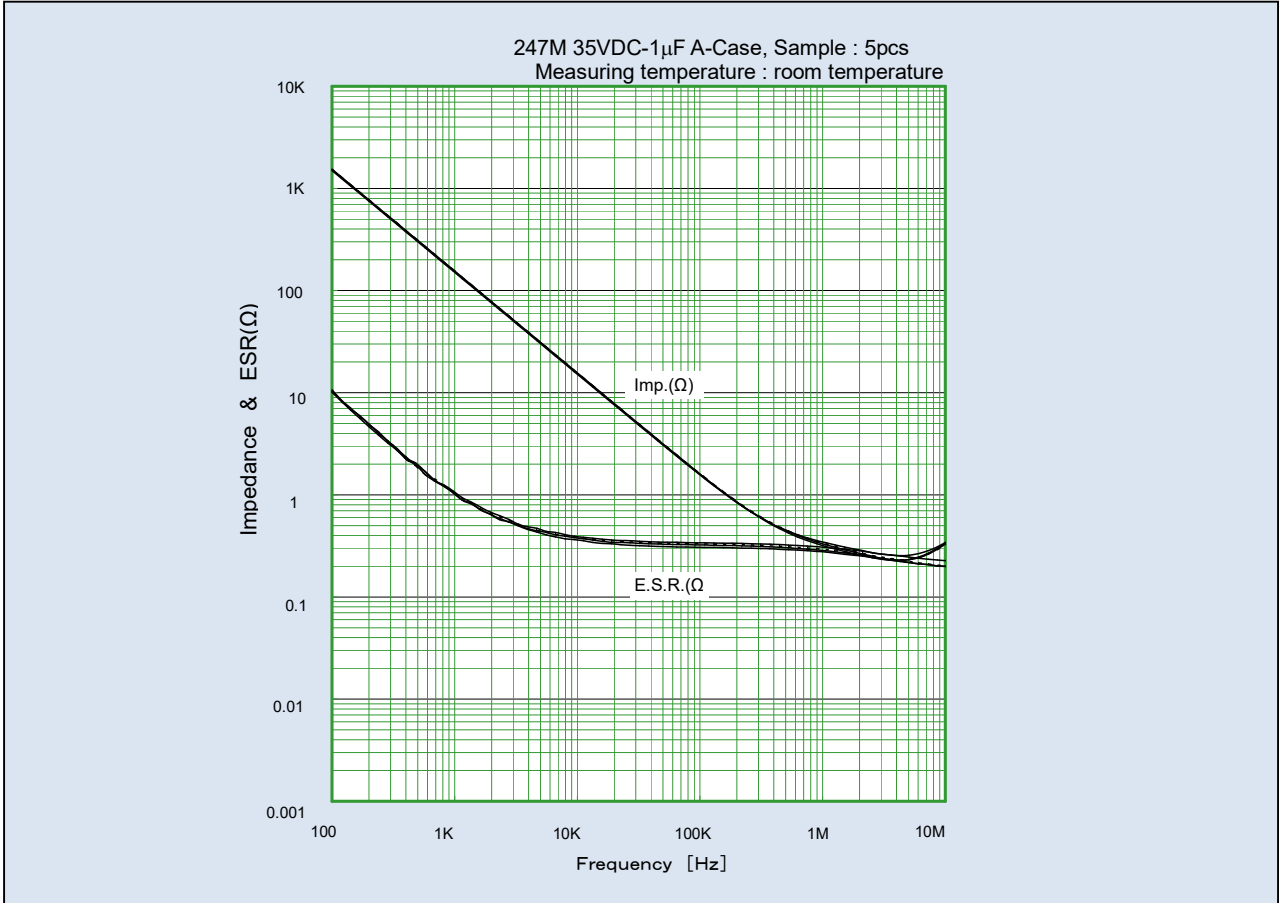

TEMPERATURE CHARACTERISTICS

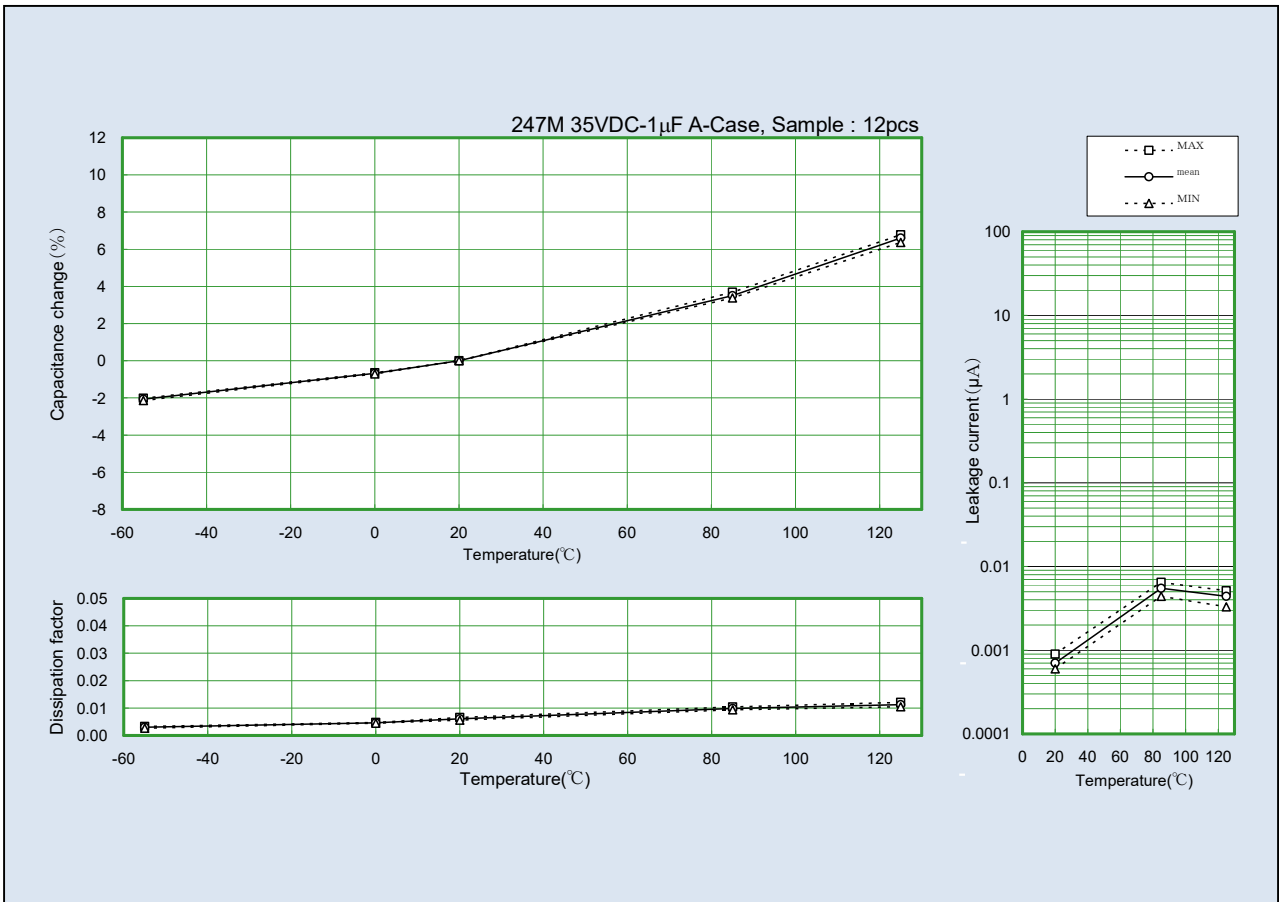

DAMP HEAT, STEADY STATE 40°C, 95%RH

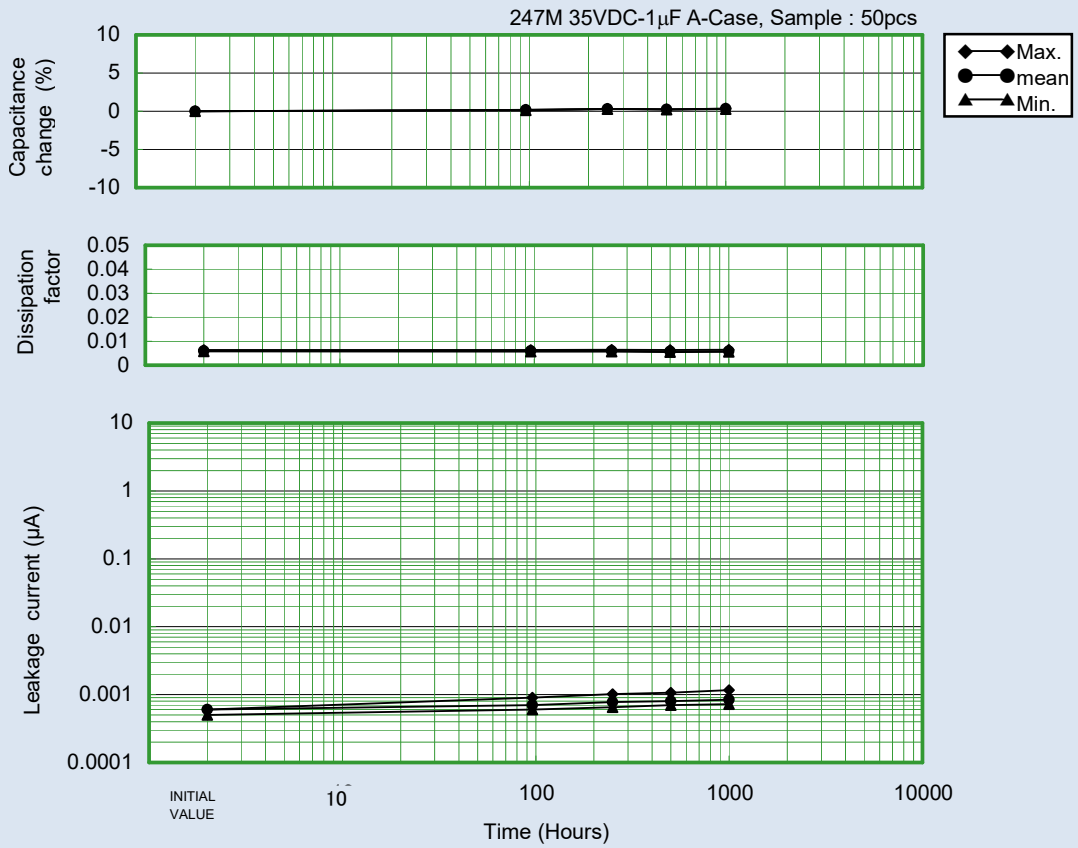

ENDURANCE 85°C, RATED VOLTAGE

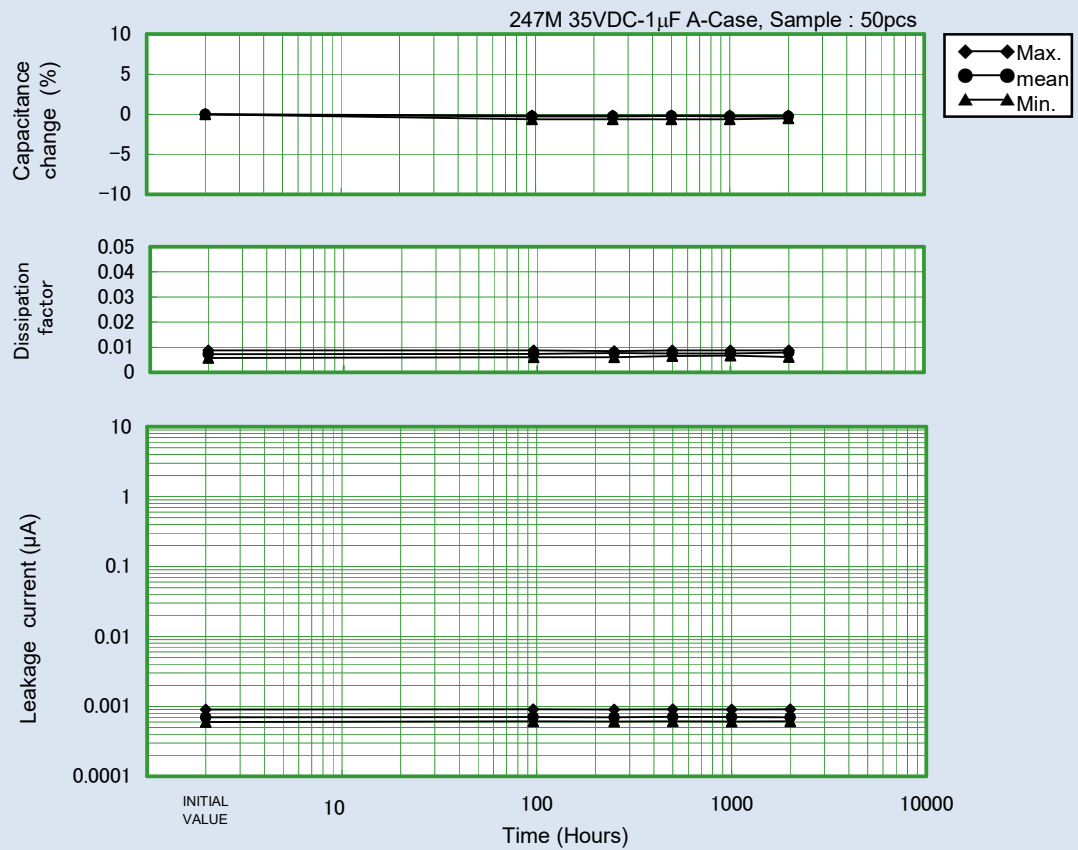

FUSING CHARACTERISTICS

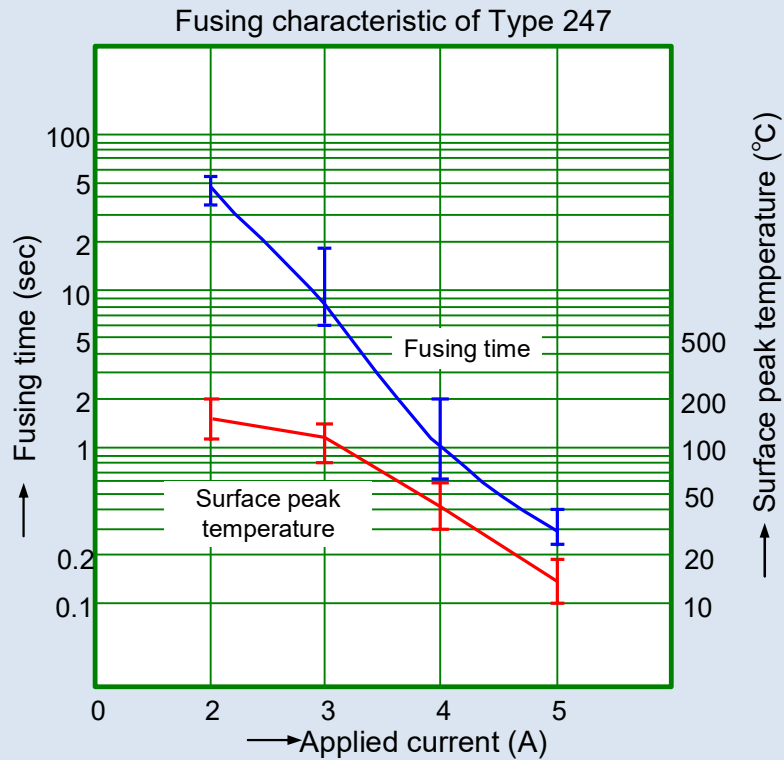

(1) Performance

- (a) Fusing time⁽¹⁾ : 10A 25 sec or less, 15A 10 sec or less
 (b) Surface temperature : 350°C or less

(2) Test method

- (a) Sample : Sample shall be applied overload voltage (about 300V, 100mA) at right direction and shorted. At that time, resistance value of sample shall be 1 Ω or less.
- (b) Test method : On 5 voltage, fusing electric current shall be set to the sample in the opposite direction for the polarity. Sample shall be measured the time and surface temperature when the sample is open circuit mode.

Note⁽¹⁾ If fusing electric current is not consecutive or surface temperature does not exceed 250°C, fuse may not be cut off.

⚠ Application Notes for Tantalum Solid Electrolytic Capacitor (Type 247)

1. Operating Voltage

Tantalum Solid Electrolytic Capacitor shall be operated at the rated voltage or lower.

Rated voltage: The “rated voltage” refers to the maximum DC voltage that is allowed to be continuously applied between the capacitor terminals at the rated temperature.

Surge voltage: The “surge voltage” refers to the voltage that is allowed to be instantaneously applied to the capacitor at the rated temperature or the maximum working temperature. The capacitor shall withstand the voltage when a 30-second cycle of application of the voltage through a 1000 Ω series resistance is repeated 1000 times in 6-minute periods.

Rated voltage (VDC)	6.3	10	16	20	25	35	50
Surge voltage (VDC)	8	13	20	25	32	44	63

When designing the circuit, the equipment’s required reliability must be considered and appropriate voltage derating must be performed. Figure 1 shows the recommended voltage derating curve for Tantalum capacitors as described by NASA APPLICATION NOTES.

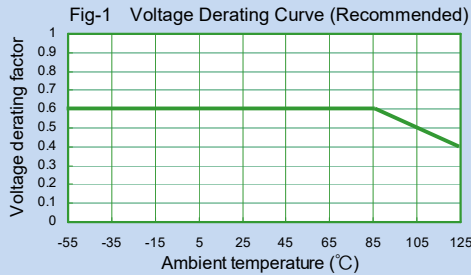

2. Application that contain AC Voltage

Special attention to the following 3 items.

- (1) The sum of the DC bias voltage and the positive peak value of the AC voltage should not exceed the rated voltage.
- (2) Reverse voltage should not exceed the allowable values of the negative peak AC voltage.
- (3) Ripple current should not exceed the allowable values.

3. Reverse Voltage

Tantalum solid electrolytic capacitor is polarity. Please do not impress reverse voltage. As well, please confirm the potential of the tester beforehand when both ends of the capacitor are checked with the tester etc.

4. Permissible Ripple Voltage

Permissible ripple voltage is determined by the heat loss of the element and heat radiation of the lead wire. This is influenced by capacitance, ESR, operating temperature, and frequency or ripple. Please consult Matsuo’s Engineering Bulletin for details on calculating ripple current values.

5. Application on low-impedance circuit

The failure rate of low impedance circuit at 0.1Ω/V is about five times greater than that of a 1Ω/V circuit. To curtail this higher failure rate, tantalum capacitors used in low impedance circuits, such as filters for power supplies, particularly switching power supplies, or for noise by-passing, require that operating voltage be derated to less than half of the rated voltage. Actually, less than 1/3 of the rated voltage is recommended.

6. Non Polar Application(BACK TO BACK)

Tantalum capacitors can be used as a non-polar unit if two capacitors are connected “BACK-TO-BACK” when reserve voltage is applied at a more than permissible value, or in a purely AC circuit. The two capacitors should both be of the same rated voltage and capacitance tolerance, and they should both be twice the required capacitance value.

Ripple Voltage: Permissible Ripple Voltage shall not exceed the value allowed for either C1 or C2 (This will be the same, as the capacitors should be identical.)

Capacitance: $(C1 \times C2) / (C1 + C2)$

Leakage Current: If terminal A is (+), the Leakage Current will be equal to C1’s Leakage Current.

If terminal B is (+), the Leakage Current will be equal to C2’s Leakage Current.

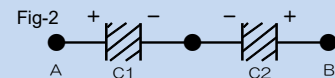

7. Soldering

The soldering of Type 247 should be operated per the following recommended conditions.

(1) Flow Soldering

This type soldering is a way to solder parts from under the glass-epoxy PC board regarding which parts are put into hole of the board.

Figure 3 shows temperature and dipping time of solder Bath.

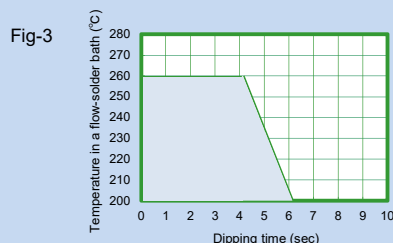

(2) Soldering with a Soldering Iron

It is a soldering method that parts are heated up under board by soldering iron after putting parts into through-hole of PC board such as item 7.11. Allowance is shown in Figure 4 regarding temperature and holding time of soldering iron.

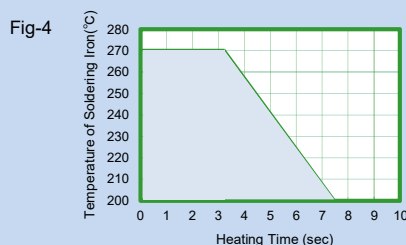

8. Example of trouble phenomenon happening by excessive heating when soldering

When mounting, the following breakdown phenomena might be caused when excessive heating that exceeds the above-mentioned tolerance is done. Therefore, please pay attention to the operation.

In a case that solder is used for cathode connection of molding type product, Ag in silver paste could merge into solder if solder in product have melted. That might cause excessive Leakage Current and Short etc. by changing in deterioration in DF and the high frequency impedance or internal stresses in that case.

Mechanical stress according to heat stress and expansion shrinkage or concentrations of internal stress might increase failure rate.

9. Flux

Please use flux as much as possible with non-acidity and little content of both chlorine and amine.

10. Cleaning

Cleaning by organic solvent may damage capacitor's appearance and performance. However, our capacitors are not effected even when soaked at 20 ~ 30°C 2-propanol for 5 minutes. When introducing new cleaning methods or changing the cleaning term, please consult us.

11. Protective Resin Coating

After components are assembled to substrate, a protective resin coating is sometimes applied. As this resin coating cures, it gives mechanical and thermal stress to Tantalum capacitors. This stress can cause damage to the capacitors, which affects their reliability. Before using a resin coating, proper research must be done in regards to the material and process to insure that excessive stress will not be applied to capacitors and other components.

12. Vibration

Approximately 300 G shall be applied to a capacitor, when dropped from 1 meter to a concrete floor.

Although capacitors are made to withstand this drop test, stress from shock due to falling or striking does cause damage to the capacitors and increases failure rates. Do not subject capacitors to this type of mechanical stress.

13. Additional Notes

- When more than one capacitor is connected in series, a resistor that can distribute the voltage equally to the capacitors shall be connected in parallel.
- The capacitor cases shall not be cut even if the mounting space is insufficient.
- During a customers aging process, voltage should remain under the rated voltage at all times.
- Capacitors should never be touched or manipulated while operating.
- Capacitors are not meant to be dismantled.
- When testing capacitors, please examine the power source before conducting test to insure the tester's polarity and applied voltage.
- In the event of a capacitor burning, smoking, or emitting an offensive smell during operation, please turn the circuit "off" and keep hands and face away from the burning capacitor.
- If a capacitor be electrical shorted, it becomes hot, and the capacitor element may ignite.
In this case, the printed board may be burnt out.
- Capacitors should be stored at room temperature under low humidity. Capacitors should never be stored under direct sunlight, and should be stored in an environment containing dust.
- If the capacitors will be operated in a humid environment, they should be sealed with a compound under proper conditions.
- Capacitors should not be stored or operated in environments containing acids, alkalis or active gasses.
- When capacitors are disposed of as "scrap" or waste, they should be treated as Industrial Waste since they contain various metals and polymers.
- Capacitors submitted as samples should not be used for production purposes.

These application notes are prepared based on "Guideline of notabilia for fixed tantalum electrolytic capacitors with solid electrolyte for use in electronic equipment" (RCR-2368) issued by Japan Electronics and Information Technology Industries Association (JEITA). For the details of the instructions (explanation, reasons and concrete examples), please refer to this guideline, or consult our Sales Department.



MATSUO ELECTRIC CO., LTD.

Please feel free to ask our Sales Department for more information on Tantalum Solid Electrolytic Capacitor.

Overseas Sales 5-3,3-Chome,Sennari-cho,Toyonaka-shi,Osaka 561-8558,Japan Tel:06-6332-0883 Fax:06-6332-0920
Head office 5-3,3-Chome,Sennari-cho,Toyonaka-shi,Osaka 561-8558,Japan Tel:06-6332-0871 Fax:06-6331-1386
URL <https://www.ncc-matsuo.co.jp/>

Specifications on this catalog are subject to change without prior notice. Please inquire of our Sales Department to confirm specifications prior to use.